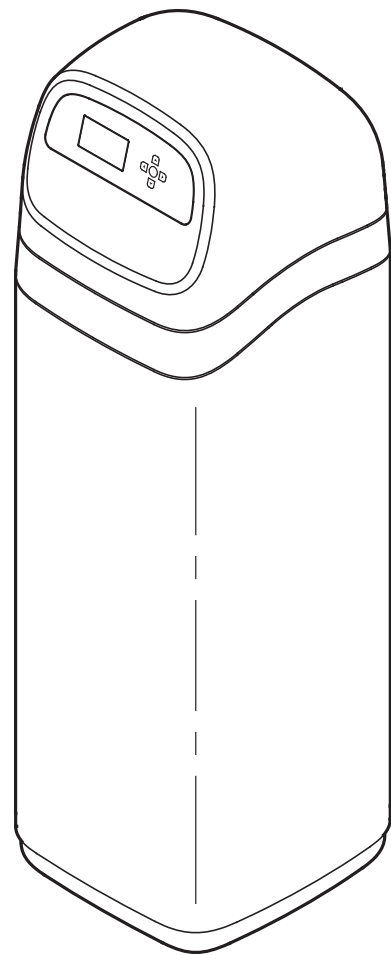


# OWNER'S MANUAL

How to install, operate and maintain your  
**EcoWater Systems**  
Chloramine & Chlorine  
Central Water Filtration System



Model  
**ETF2300ECCWS**



Point-of-entry system tested and certified by NSF International for NSF/ANSI/CAN Standard 372, and is not certified for material safety, contaminant reductions, or structural integrity by NSF International.



Designed, Engineered &  
Assembled in the U.S.A.

EcoWater Systems LLC  
P.O. Box 64420, St. Paul, MN 55164-0420  
[www.ecowater.com](http://www.ecowater.com)

7400803 (Rev. D 2/6/25)

**TABLE OF CONTENTS**

	<u>Page</u>
Warranty .....	3
Specifications & Dimensions .....	4
Before Starting Installation .....	5-6
Typical Installation Illustrations .....	7
Installation .....	8-9
Start Up Procedure .....	10
General Information .....	11
Setup Procedure .....	12-13
Filter Operation .....	14-25
Care of the Central Water Filtration System .....	26
Service Information .....	27-33
Troubleshooting Guide .....	28-29
Wiring Schematic .....	33
Repair Parts .....	34-37

**SAFETY GUIDES**

Follow the installation instructions carefully. Failure to install the EcoWater Systems Central Water Filtration System properly **voids the warranty**.

Before you begin installation, read this entire manual. Then, obtain all the materials and tools you will need to make the installation.

**Check local plumbing and electrical codes.** The installation must conform to them.

**Use only lead-free solder and flux** for all sweat-solder connections, as required by state and federal codes.

Use care when handling the EcoWater Systems Central Water Filter. Do not turn upside down, drop, or set on sharp protrusions.

Do not locate the EcoWater Systems Central Water Filter where freezing temperatures occur. Do not attempt to treat water over 120°F. **Freezing, or hot water damage voids the warranty.**

The EcoWater Systems Central Water Filter requires a minimum water pressure of 30 psi at the inlet.

**Maximum allowable inlet water pressure is 125 psi.** If daytime pressure is over 80 psi, nighttime pressure may exceed the maximum. Use a pressure reducing valve if necessary (Adding a pressure reducing valve may reduce the flow).

The EcoWater Systems Central Water Filter works on **24V DC** electrical power, supplied by a direct plug-in power supply (included). Be sure to use the included power supply, and plug it into a nominal **120V, 60 Hz** household outlet that is in a **dry location only**, grounded and properly protected by an overcurrent device such as circuit breaker or fuse.

This system is not intended to be used for treating water that is microbiologically unsafe or of unknown quality without adequate disinfection before or after the system.

**FCC NOTICE**

**NOTE:** This equipment has been tested and found to comply with the limits for a Class B digital device, pursuant to Part 15 of the **FCC** Rules. These limits are designed to provide reasonable protection against harmful interference in a residential installation. This equipment generates, uses, and can radiate radio frequency energy and, if not installed and used in accordance with the instructions may cause harmful interference to radio communications. However, there is no guarantee that interference will not occur in a particular installation. If this equipment does cause harmful interference to radio or television reception, which can be determined by turning the equipment off and on, the user is encouraged to try to correct the interference by one or more of the following measures:

- Reorient or relocate the receiving antenna.
- Increase the separation between the equipment and receiver.
- Connect the equipment into an outlet on a circuit different from that to which the receiver is connected.
- Consult the dealer or an experienced radio/TV technician for help.

Changes or modifications not expressly approved by EcoWater Systems could void the user's authority to operate the equipment.

This device complies with **Industry Canada** Standard RSS-210. Operation is subject to the following two conditions: (1) this device may not cause interference, and (2) this device must accept any interference, including interference that may cause undesired operation of the device.

Ce dispositif est conforme avec la norme CNR-210 **d'Industrie Canada**. Le fonctionnement du dispositif est sujet aux deux conditions suivantes: (1) le dispositif ne doit pas causer de brouillage, et (2) le dispositif doit accepter tous brouillages, incluant tous brouillages qui peut nuire au bon fonctionnement du dispositif.



European Directive 2002/96/EC requires all electrical and electronic equipment to be disposed of according to Waste Electrical and Electronic Equipment (WEEE) requirements. This directive or similar laws are in place nationally and can vary from region to region. Please refer to your state and local laws for proper disposal of the equipment.

**LIMITED WARRANTY**  
**EcoWater Systems LLC Advantage Warranty**  
**ETF2300ECCWS Central Water Filtration System**

Congratulations! You have just purchased the highest quality water conditioning product on the market.

**To whom is this warranty extended?**

EcoWater Systems LLC warrants its products to the original purchaser, when the product is purchased from an authorized dealer, and guarantees that the products will be free from defects in materials and workmanship from the date that the product is delivered.

**How does my warranty work?**

If, during the respective warranty period, a part proves, after inspection by EcoWater, to be defective, EcoWater will, at its sole option repair or replace that part at no charge, other than normal shipping, installation or service charges.

**What is covered by the warranty?**

EcoWater Systems LLC guarantees that, for the LIFETIME of the original purchaser, when the product is purchased from an authorized dealer, the MINERAL TANK will not rust, corrode, leak, burst, or in any other manner fail to perform in accordance with its written specifications, and that, for a period of TEN (10) YEARS from the date the product is delivered, the MEDIA BED will be free of defects in materials and workmanship and will reduce chloramines and chlorine taste and odor from a municipal water supply, in accordance with its written specifications, and that, for a period of TEN (10) YEARS from the date the product is delivered, the VALVE BODY will be free of defects in materials and workmanship and will perform in accordance with its written specifications, and that, for a period of SEVEN (7) YEARS from the date the product is delivered, the ELECTRONIC FACEPLATE will be free of defects in materials and workmanship and will perform in accordance with its written specifications, and that, for a period of FIVE (5) YEARS from the date the product is delivered, and ALL OTHER PARTS will be free of defects in materials and workmanship and will perform in accordance with their written specifications.

**How do I obtain warranty service?**

Should you need service, your local, independent EcoWater Dealer is only a phone call away.

PHONE: \_\_\_\_\_

To obtain warranty service, notice must be given, within thirty (30) days of the discovery of the defect, to your local EcoWater Systems dealer.

**If I need a part replaced after the factory warranty expires, is the replacement part warranted?**

Yes, EcoWater Systems LLC warrants FACTORY REPAIRS as well as all REPLACEMENT PARTS for a period of 90 DAYS. This warranty does not include normal shipping, installation or service charges.

**Are any additional warranties available?**

We are pleased to say, YES! EcoWater Systems LLC sells an EXTENDED, PARTS ONLY WARRANTY for the ELECTRONICS portion of your product. This warranty is called the "Perfect 10" and extends the warranty on the electronic FACEPLATE, WIRING HARNESS, DRIVE MOTOR, POWER SUPPLY, POWER CORD, SENSOR HOUSING, and MICRO SWITCHES to a total of TEN (10) YEARS from the date the product is delivered. Your local dealer will provide details regarding this warranty or will refer you to the factory for additional information. Should your local dealer not offer this warranty, you may contact the factory for additional information. This guarantee may be subject to normal shipping and installation or service charges.

**General Provisions**

The above warranties are effective provided the central water filtration system is operated at water pressures not exceeding 125 psi (8.8 kg/cm<sup>2</sup>), and at water temperatures not exceeding 120°F (49°C); provided further that the central water filtration system is not subject to abuse, misuse, alteration, neglect, freezing, accident or negligence; and provided further that the central water filtration system is not damaged as the result of any force of nature such as, but not limited to, flood, hurricane, tornado or earthquake.

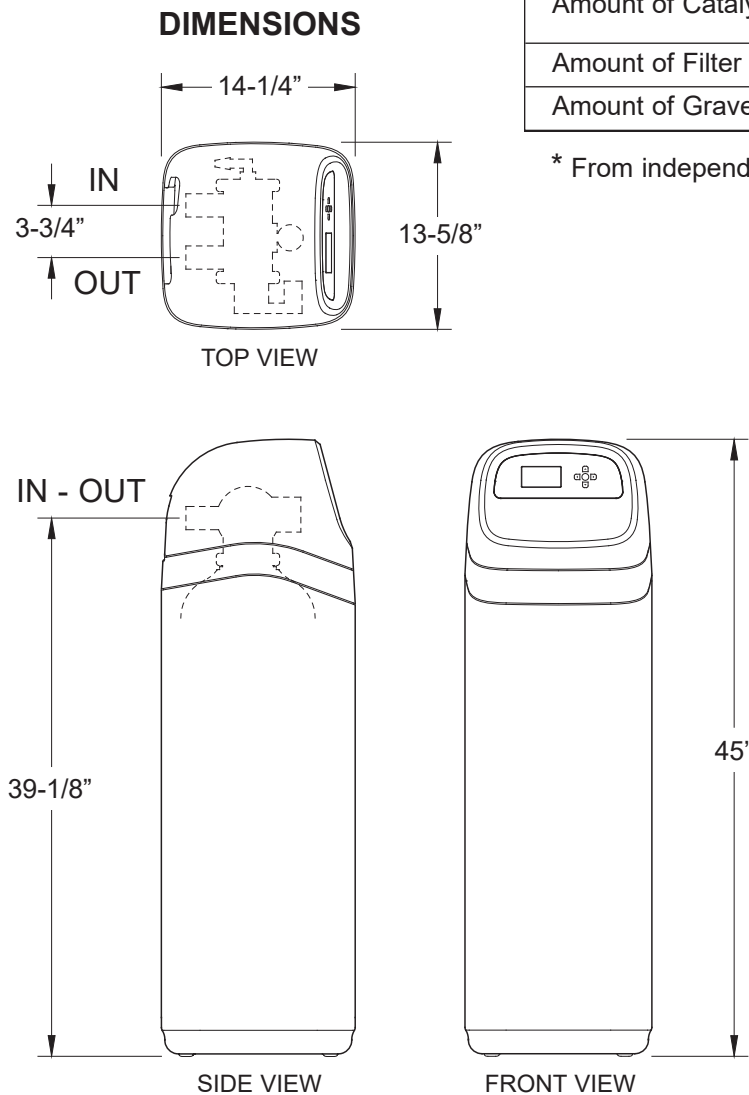
The limited warranty does not cover damage due to: (a) transportation, (b) storage, (c) improper use, (d) failure to follow the product instructions or to perform any preventive maintenance, (e) modifications, (f) unauthorized repair, (g) normal wear and tear, or (h) external causes such as accidents, abuse, or other actions or events beyond Warrantor's reasonable control. Use of aftermarket, used, or non-manufacturer provided parts will void all warranties. Warranty does not cover failures due to improper product installation. Warrantor is excused if failure to perform its warranty obligations is the result of strikes, government regulation, materials shortages, or other circumstances beyond its control.

THERE ARE NO WARRANTIES ON THE CENTRAL WATER FILTRATION SYSTEM BEYOND THOSE SPECIFICALLY DESCRIBED ABOVE. ALL IMPLIED WARRANTIES, INCLUDING ANY IMPLIED WARRANTY OF MERCHANTABILITY OR OF FITNESS FOR A PARTICULAR PURPOSE, ARE DISCLAIMED TO THE EXTENT THEY MIGHT EXTEND BEYOND THE ABOVE PERIODS. THE SOLE OBLIGATION OF WARRANTOR UNDER THESE WARRANTIES IS TO REPLACE OR REPAIR THE COMPONENT OR PART WHICH PROVES TO BE DEFECTIVE WITHIN THE SPECIFIED TIME PERIOD, AND WARRANTOR IS NOT LIABLE FOR CONSEQUENTIAL OR INCIDENTAL DAMAGES. NO DEALER, AGENT, REPRESENTATIVE, OR OTHER PERSON IS AUTHORIZED TO EXTEND OR EXPAND THE WARRANTIES EXPRESSLY DESCRIBED ABOVE.

Some states do not allow the exclusion or limitation of incidental or consequential damages, so the above limitation or exclusion may not apply to you. This warranty gives you specific legal rights, and you may have other rights which vary from state to state. This warranty applies to consumer-owned installations only.

<b>SPECIFICATIONS</b>	
<b>Model</b>	<b>ETF2300ECCWS</b>
Model Code	EC
Nominal Mineral Tank Size	8" dia. x 35"
Rated Service Flow Rate	10 gpm (37.8 L/min.)
Pressure Drop at Rated Service Flow	6 psig* (41.3 kPa)
Pressure Drop at 12 gpm	9 psig* (62.0 kPa)
Water Pressure Limits (minimum / maximum)	30 - 125 psi (206.8 - 861.8 kPa)
Water Temperature Limits (minimum / maximum)	40 - 120 °F (4 - 49 °C)
Chloramine Removal	>70%
Backwash Time, default (length is adjustable)	2 minutes
Fast Rinse Time, default (length is adjustable)	1 minute
Drain Flow Rate (during Backwash & Fast Rinse)	3.0 gpm
Amount of Catalytic Carbon	16 pounds (0.57 cu. ft.)
Amount of Filter Sand	5 pounds
Amount of Gravel	6 pounds

\* From independent laboratory test data.



**FIG. 1**

## UNPACKING

EcoWater Systems Central Water Filtration System is shipped from the factory in one master carton. The carton also includes a bag of small parts needed to assemble and install the unit, plus this manual.

Thoroughly check the Central Water Filtration System for possible shipping damage and parts loss. Also inspect and note any damage to the shipping carton. Notify the transportation company if damage is present. EcoWater Systems is not responsible for in-transit damages.

Remove and discard (RECYCLE) all packing materials. We suggest you keep the small parts in the bag(s) until you are ready to use them.

## WHERE TO INSTALL THE CENTRAL WATER FILTRATION SYSTEM

- To condition all water in the home, install the Central Water Filtration System close to the water supply inlet, and before all other plumbing connections, except outside water pipes.
- Install the Central Water Filtration System between the home's incoming water supply and the water softener, if one is being used (See Figures 2A & 2B).
- A nearby drain is needed to carry away Clean Rinse discharge water. Use a floor drain, laundry tub, sump, standpipe, or other options (check your local codes). See "Air Gap Requirements" and "Valve Drain Requirements" sections. If a drain is not available, it is still possible to operate the Central Water Filtration System in a manual Clean Rinse mode. See "Operating in Manual Clean Rinse Mode." The automatic Clean Rinse must be disabled if the Central Water Filtration System will not be connected to a drain (See Page 11).
- Connect the Central Water Filtration System to the main water supply pipe UPSTREAM OF the water heater. DO NOT RUN HOT WATER THROUGH THE FILTER. The temperature of water passing through the filter must be less than 120°F.
- Keep outside faucets on unfiltered water to conserve filtering capacity.
- Do not install the Central Water Filtration System in a place where it could freeze. Damage caused by freezing is not covered by the warranty.
- Put the Central Water Filtration System in a place water damage is least likely to occur if a leak develops. The manufacturer will not repair or pay for water damage.

- A 120V, 60 Hz electrical outlet, to plug the included power supply into, is needed near the Central Water Filtration System. Be sure the electrical outlet and power supply are in an inside location, to protect from wet weather.
- If installing in an outside location, you must take the steps necessary to assure the Central Water Filtration System, installation plumbing, wiring, etc., are as well protected from the elements, contamination, vandalism, etc., as when installed indoors.
- A drain is needed for recharge discharge water. A floor drain is preferred, close to the Central Water Filtration System. A laundry tub, standpipe, etc., are other options. Be sure to provide a 1-1/2" minimum air gap, to prevent possible sewer water backup.

## TOOLS, PIPE & FITTINGS, OTHER MATERIALS YOU WILL NEED

- Plastic inlet and outlet fittings included with the filter allow water flow equivalent to 1 inch nominal pipe. To maintain full valve flow, 1" pipes to and from the filter fittings are recommended. Do not reduce the pipes to less than 3/4" size.
- Use copper, brass or PEX plastic pipe and fittings.
- ALWAYS install the included bypass valve, or 3 shut-off valves. Bypass valves let you turn off water to the filter for repairs if needed, but still have water available to the house pipes.
- Drain hose, 1/2" inside diameter minimum, is needed for the valve drain. See step 5 on page 9.
- If a rigid valve drain is needed, to comply with plumbing codes, you can buy the parts needed (see page 7) to connect a 1/2" minimum copper tubing drain.

## PLAN HOW YOU WILL INSTALL THE CENTRAL WATER FILTRATION SYSTEM

You must first decide how to run in and out pipes to the filter. Look at the house main water pipe at the point where you will connect the filter. Is the pipe soldered copper, glued plastic, or threaded brass/galvanized? What is the pipe size?

Now look at the typical installation illustration on page 7. Use it as a guide when planning your particular installation. Be sure to direct incoming, unfiltered water to the filter valve inlet fitting. The valve ports are marked IN and OUT.

**PLUMBING CODES**

All plumbing must be completed in accordance with national, state and local plumbing codes.

In the state of Massachusetts: The Commonwealth of Massachusetts plumbing code 248-CMR shall be adhered to. A licensed plumber shall be used for this installation.

**AIR GAP REQUIREMENTS**

A drain is needed for Clean Rinse discharge water. A floor drain, close to the Central Water Filtration System, is preferred. A laundry tub, standpipe, etc. are other drain options. Secure valve drain hose in place. Leave an air gap of 1-1/2" between the end of the hose and the drain. This gap is needed to prevent backflow of sewer water into the Central Water Filtration System. Do not put the end of the drain hose into the drain.

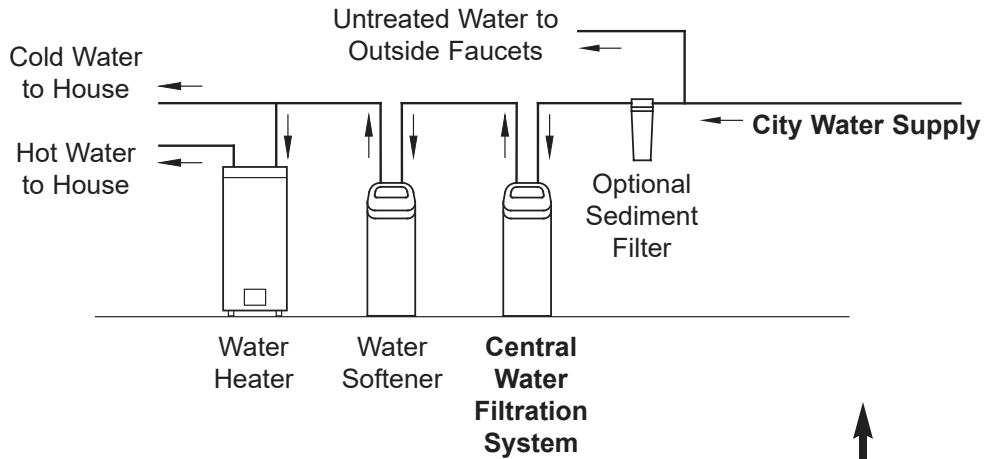
**VALVE DRAIN REQUIREMENTS**

Using 1/2" I.D. flexible drain hose, measure and cut to the length needed. Flexible drain hose is not allowed in all localities (check your plumbing codes). If local codes do not allow use of a flexible drain hose, a rigid valve drain run must be used. Purchase a compression fitting (1/2 NPT x 1/2 in. minimum tube) and 1/2" tubing from your local hardware store. Plumb a rigid drain as needed (see Figure 5).

**NOTE:** Avoid drain hose runs longer than 30 feet. Make the valve drain line as short and direct as possible.

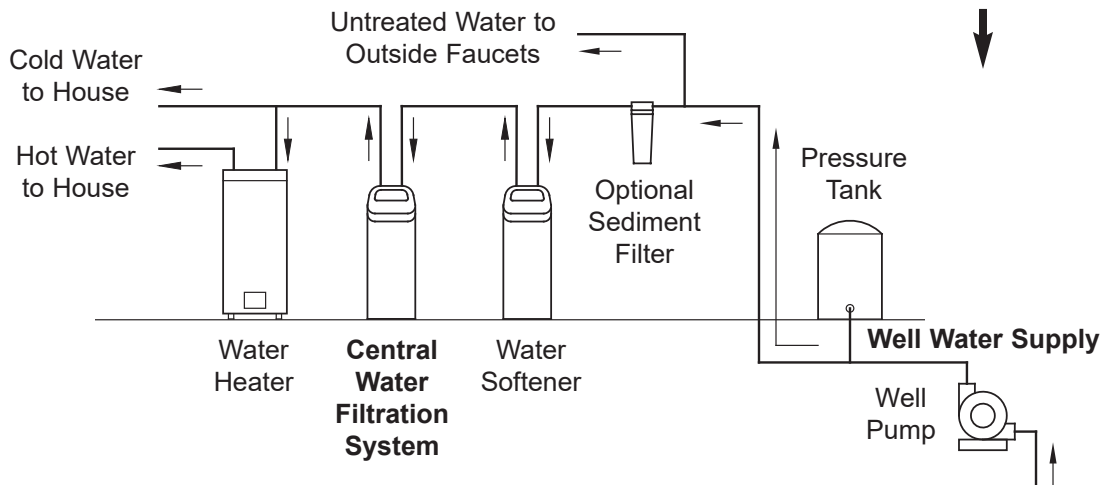
It is recommended that the Central Water Filtration System be installed near a drain. However, if a drain is not available, it is still possible to operate the Central Water Filtration System in a manual Clean Rinse mode. See "Operating in Manual Clean Rinse Mode" section. The automatic Clean Rinse function must be disabled if the Central Water Filtration System will not be connected to a drain.

**THE PROPER ORDER TO INSTALL WATER TREATMENT EQUIPMENT**



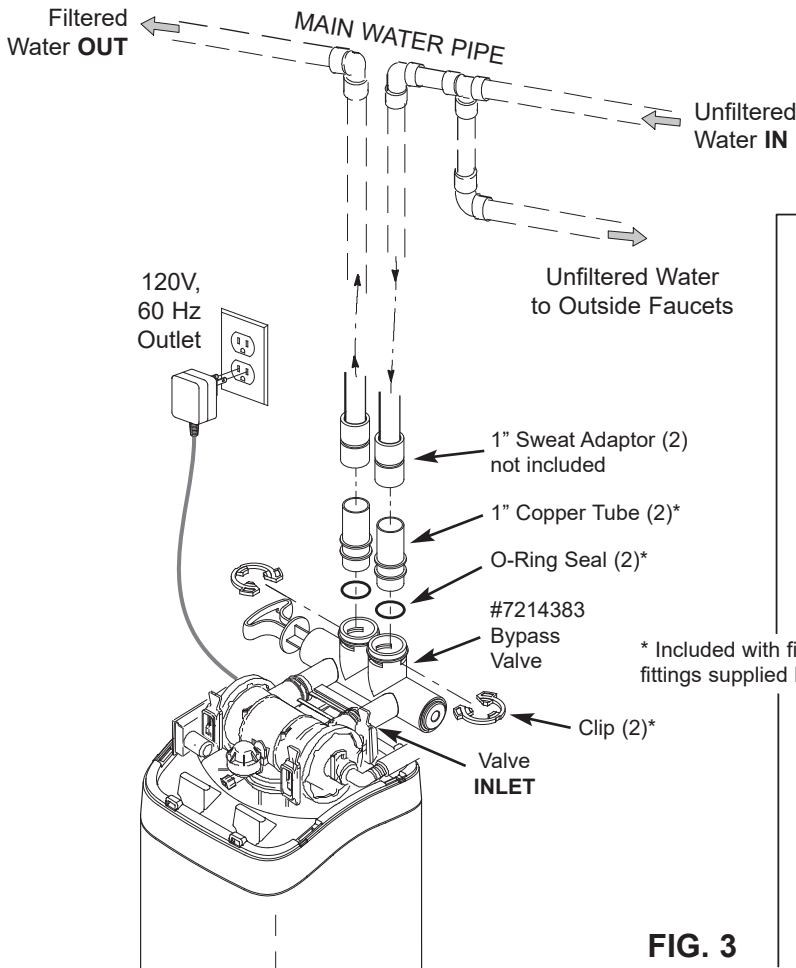
**FIG. 2A**

↑  
**OR**  
↓

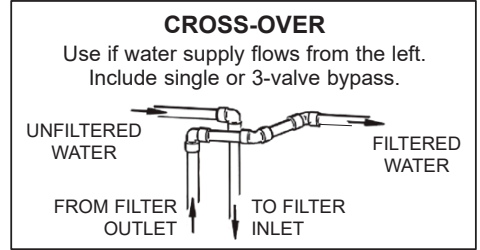


**FIG. 2B**

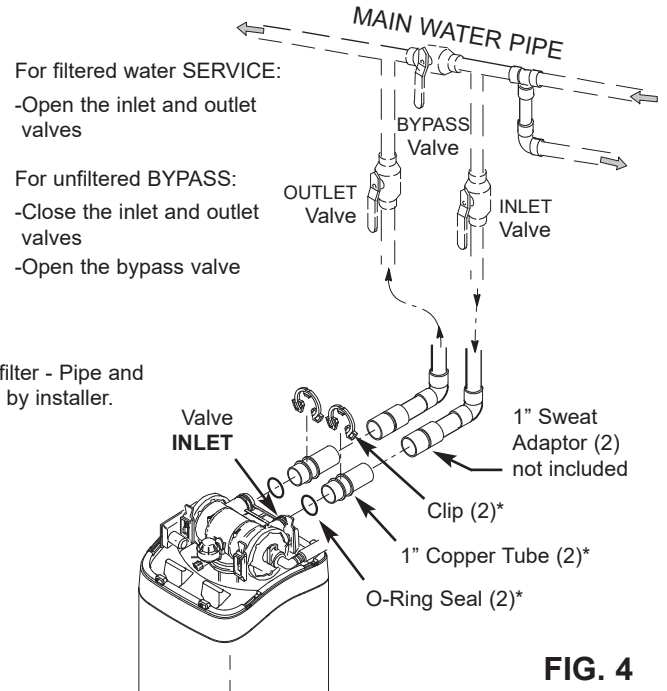
**INSTALLATION USING ECOWATER BYPASS VALVE**



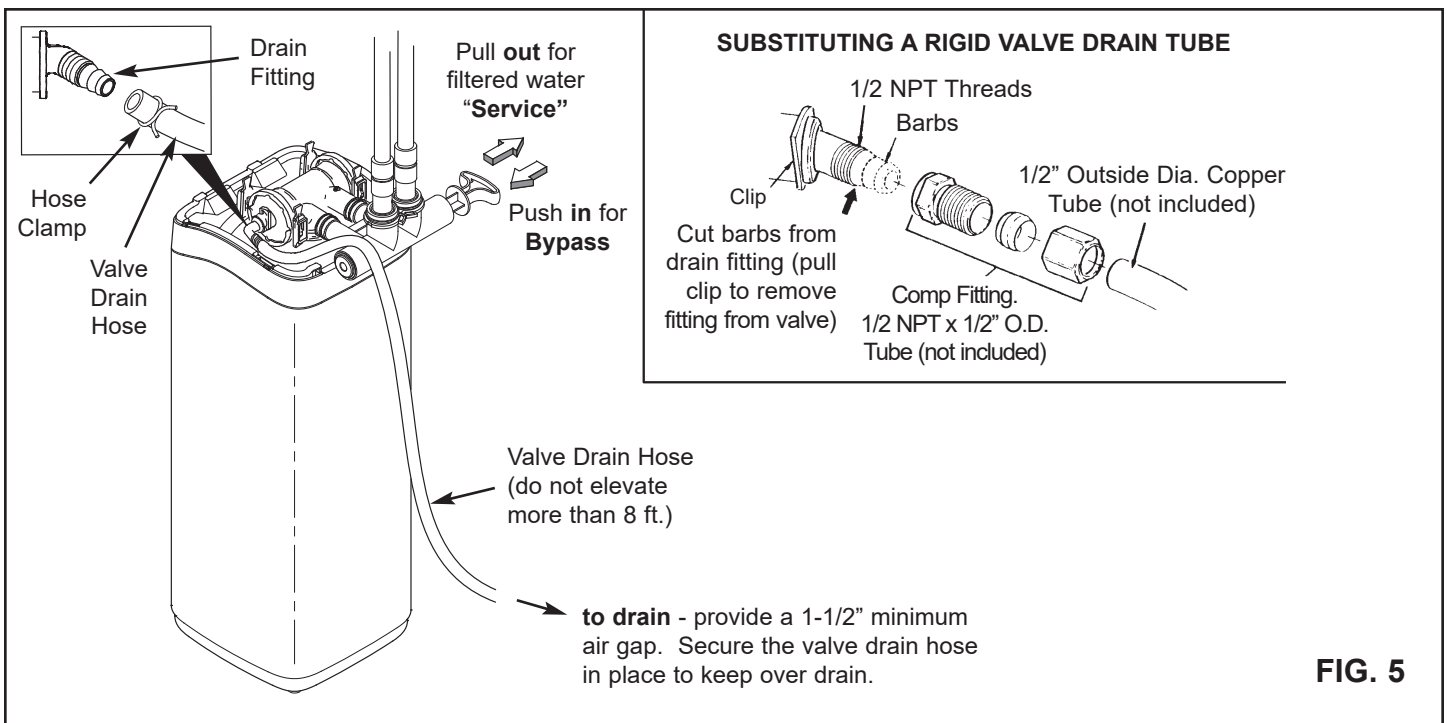
**FIG. 3**



**INSTALLATION USING 3-VALVE BYPASS**



**FIG. 4**



**FIG. 5**

**1. TURN OFF WATER SUPPLY**

- a. Close the main water supply valve near the well pump or water meter.
- b. Shut off the electric or fuel supply to the water heater.
- c. Open high and low faucets to drain all water from the house pipes.

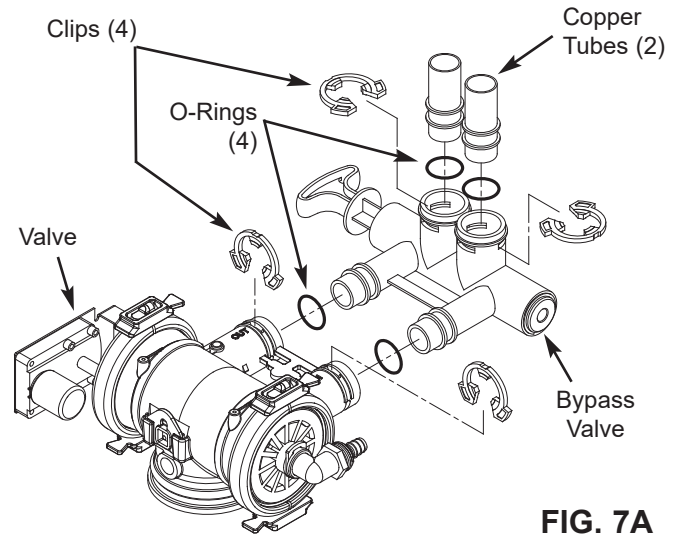
**2. INSTALL BYPASS VALVE AND/OR PLASTIC ADAPTOR / COPPER TUBE:**

- a. If installing a single bypass valve, push the bypass valve, with lubricated o-ring seals in place, into the valve inlet and outlet ports (See Figures 3 & 7A).
- OR -
- b. If installing a 3-valve bypass system, slide plastic installation adaptor and copper tube, with lubricated o-ring seals in place, into the valve inlet and outlet ports, respectively (See Figures 4 & 7B).
- c. Make sure that the turbine and support are in place in the valve outlet, as shown in Figure 8.
- d. Snap the two large plastic clips in place on the inlet and outlet ports, from the top, down (See Figure 9). Be sure they snap into place. Pull on the bypass valve, copper tube or plastic adaptor, to make sure they are held securely in place.

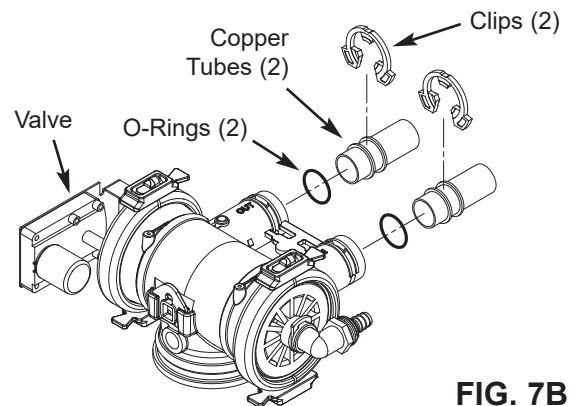
**3. COMPLETE PLUMBING TO AND FROM THE FILTER**

Using the "Typical Installation Illustrations" on page 7 as a guide, observe all of the following cautions while you connect inlet and outlet plumbing:

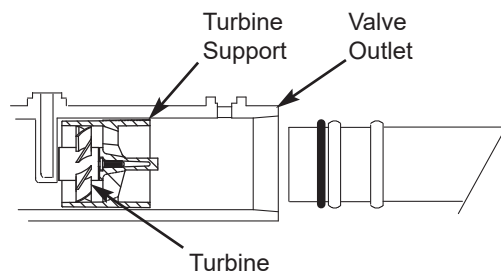
- Be sure incoming, **unfiltered water** is directed to the valve **INLET** port.
- Be sure to install bypass valve(s).
- If making a soldered copper installation, do all sweat soldering before connecting pipes to the filter fittings. Torch heat will damage plastic parts.
- Use pipe joint compound on all external pipe threads.
- When turning threaded pipe fittings onto plastic fittings, use care not to cross-thread.
- Support inlet and outlet plumbing in some manner (use pipe hangers) to keep the weight off of the valve fittings.



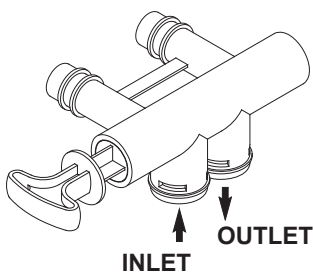
**FIG. 7A**



**FIG. 7B**

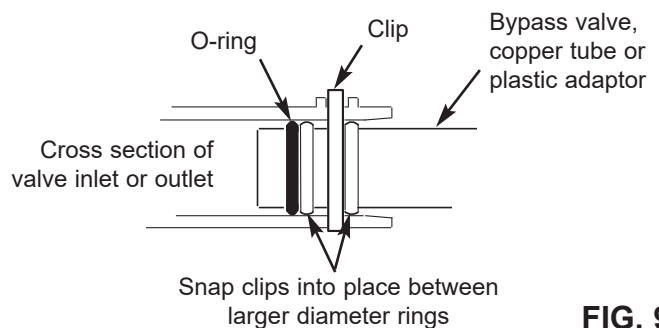


**FIG. 8**



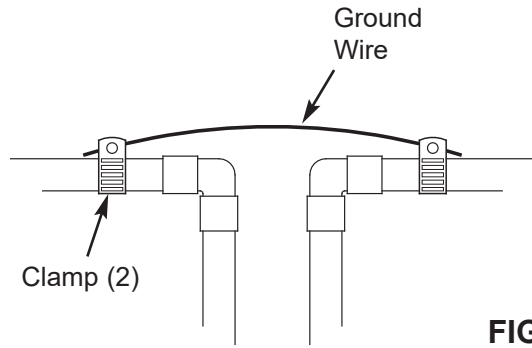
Turn the bypass valve downward if connecting to floor level plumbing

**FIG. 6**



**FIG. 9**





**FIG. 10**

#### 4. COLD WATER PIPE GROUNDING

The house cold water pipe (metal only) is often used as a ground for the house electrical system. The 3-valve bypass type of installation, shown in Figure 4, will maintain ground continuity. If you use the plastic bypass, continuity is broken. To restore the ground, do the following:

- a. Install a #4 copper wire across the removed section of main water pipe, securely clamping at both ends (See Figure 10). Parts not included.

#### 5. INSTALL VALVE DRAIN HOSE

- a. Take a length of 1/2" I.D. hose and attach to the valve drain elbow fitting (See Figure 5 on page 7). Use a hose clamp to hold the hose in place.
- b. Locate the other end of the hose at a suitable drain point (floor drain, sump, laundry tub, etc.). Check and comply with local codes. Refer to Figure 5 on page 7 if codes require a rigid pipe drain run.

**IMPORTANT:** Use high quality, thick wall hose that will not easily kink or collapse. The filter will not backwash properly if water cannot exit this hose during recharges.

- c. Tie or wire the hose in place at the drain point. Water pressure will cause it to whip during the backwash portion of the recharge cycle. Also provide an air gap of at least 1-1/2" between the end of the hose and the drain point. An air gap prevents possible siphoning of sewer water, into the filter, if the sewer should back up.
- d. If raising the drain hose overhead is required to get to the drain point, do not raise higher than 8 feet above the floor. Elevating the hose may cause a back pressure that could reduce backwash flow and proper mineral bed cleaning.

#### 6. PRESSURE TESTING FOR LEAKS

To prevent excessive air pressure in the EcoWater Central Water Filtration System and plumbing system, do the following steps **EXACTLY** in order:

- a. Fully open two or more **filtered** cold water faucets nearby the EcoWater Systems filter.
- b. Place the bypass valve(s) in **bypass** position (See Figures 4 & 5 on Page 7).
- c. Fully open the main water supply valve. Watch until the flow from the opened faucets becomes steady, with no spurting or air bubbles.
- d. **EXACTLY** as follows, place bypass valve(s) into **service**:

(1) **SINGLE BYPASS VALVE:** **Slowly** move the valve stem toward **service** position, pausing several times to allow the unit to pressurize slowly.

(2) **3-VALVE BYPASS:** Fully close the **bypass** valve and open the **outlet** valve. **Slowly** open the **inlet** valve, pausing several times to allow the unit to pressurize slowly.

- e. After about three minutes, open a hot water faucet for one minute, or until all air is expelled, then close.
- f. Close all cold water faucets and check your plumbing work for leaks.

**IMPORTANT:** Start up procedure must be run prior to using any filtered water. Follow the instructions below and on Page 10.

#### 7. CONNECT TO ELECTRICAL POWER:

The filter controller works on 24V DC electrical power. The included power supply converts 120V AC household power to 24V DC. Plug the power supply into a 120V, 60 Hz electrical outlet. Be sure the outlet is always "live" so it can not be switched off by mistake.

#### 8. PROGRAM THE CONTROLLER

See Pages 12 & 13 for instructions to program the electronic controller.

#### 12. RUN START UP PROCEDURE

Run the Start Up Procedure, as detailed on Page 10, to purge the system of fine carbon particles.

**IMPORTANT:**

**Run the start up cycle immediately after completing installation, before using any water in the home.**

The filtration media in this Central Water Filtration System contains a small number of harmless activated carbon particles generated during shipping that are small enough to exit the system with water flow. It is normal for these particles to cause a temporary discoloration of the water coming out of the system. To avoid discolored water at your home's faucets the system's start up cycle should be initiated to rinse the particles and any discolored water down the drain.

If the Central Water Filtration System is used without first running the start up cycle, you will notice that the water will temporarily have a gray color until the particles have exited the system.

**To Initiate the start up cycle:**

1. Make sure the drain hose is attached to the Central Water Filtration System and the other end is secured over a drain (see Figure 5 on Page 7).
2. Make sure bypass valve is in the "service" (open or filtered water) position and the home's water supply is turned on.
3. **Start a recharge:** From the rolling status screens, press the SELECT (○) button to display the **Main menu**. Make sure **Recharge** is highlighted, then press SELECT (○). Press DOWN (▼) to scroll to **Recharge now**, then press SELECT (○) twice. You should hear the valve motor run as the filter begins recharging.

**During the start up cycle:**

Throughout the start up cycle you will hear the valve changing position and notice the flow of water to drain starting and stopping. The start up cycle will take approximately 20 minutes. Avoid using water during this time. Do not set the time of day or press other buttons during the start up cycle, as this will interrupt the start up cycle. Do not unplug the power supply during the start up cycle. If the start up cycle is interrupted, it should be initiated again and allowed to run to completion.

**After the start up cycle:**

Once the start up procedure completes successfully, it cannot be initiated a second time. The Central Water Filtration System will automatically return to the normal operation position. Once the start up cycle has run, a faucet in the home should be opened and water allowed to run for 10 minutes at the system's rated flow. If, after running the start up cycle, the water still appears discolored, manually run Clean Rinse cycles (**Recharge now**, as described on Page 17) until the water is clear.

If the time of day was not set before the start up cycle, set it now (See Page 15).

Check the new plumbing connections and joints once more for leaks.

## **NORMAL OPERATION**

During normal operation water enters the Central Water Filtration System and flows through several filtration processes where tastes, odors and sediment are reduced.

## **CLEAN RINSE CYCLE**

A Clean Rinse cycle will automatically be initiated based on how many gallons of water have been filtered through the system (or after 14 days if no water has passed through the system in that time). The Clean Rinse cycle lifts and expands the media bed to rejuvenate the media and then repacks the bed for continued use. During the Clean Rinse cycle, dirt, sediment, etc. are flushed from the Central Water Filtration System down the drain.

## **APPLICATIONS FOR A CENTRAL WATER FILTRATION SYSTEM**

- The EcoWater Systems ECCWS is a whole home solution for removal of chloramines, chlorine taste, odors and sediment from the water in your house.
- Do not use the Central Water Filtration System with water that is microbiologically unsafe or of unknown quality without adequate disinfection before or after the system.
- The Central Water Filtration System may not be an effective treatment method for water sources with a hydrogen sulfide problem (rotten egg odor or taste).
- The Central Water Filtration System will not remove iron and is not intended to replace iron treatment equipment.
- Although the Central Water Filtration System has sediment filter capabilities, additional sediment filtration may be needed in problem water applications.

## **OPERATING IN MANUAL CLEAN RINSE MODE**

Clean Rinse cycles will run automatically, unless the automatic Clean Rinse function has been disabled. If this function has been disabled, it will be necessary to manually initiate any Clean Rinse cycles. It is recommended that a Clean Rinse cycle should be run at least once each month.

A manual Clean Rinse mode may be used when a drain (required for automatic Clean Rinse) is not available. However, it is recommended that automatic Clean Rinse be used if the drain requirements can be met.

**IMPORTANT:** During the Clean Rinse cycle, whether manually or automatically initiated, water will flow from the valve drain port at 3 gallons per min. for 3 minutes. If a permanent drain line has not been installed, provisions must be made for the drain flow prior to initiating a Clean Rinse cycle. You must have empty containers ready that will hold at least 12 gallons of water.

### **DISABLING AUTOMATIC CLEAN RINSE**

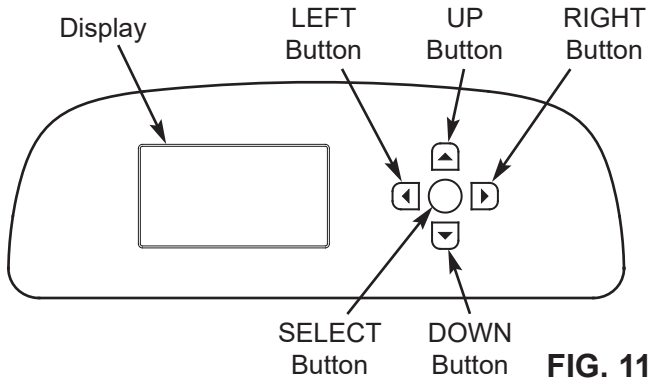
To disable the automatic Clean Rinse function, go to the Recharge menu and select **Recharge off**, as described on Page 17.

### **MANUALLY STARTING A CLEAN RINSE CYCLE**

If the drain line is not set up to discharge into a drain, you must have empty containers ready that will hold at least 12 gallons of water. To manually start a Clean Rinse cycle, go to the Recharge menu and select **Recharge now**, as described on Page 17. When the Clean Rinse cycle is complete, the Central Water Filtration System will remain in the manual Clean Rinse mode.

### **RE-ENABLING AUTOMATIC CLEAN RINSE**

To return the Central Water Filtration System to its automatic Clean Rinse function, go to the Recharge menu and select either **Schedule** or **Automatic**, as described on Page 17.



**NOTE:** If desired, Wireless Setup can also be done after the rest of the Setup Procedure (Steps 8-14) has been completed. From the **Main menu**, scroll down to the **Advanced settings** menu and select **Wireless setup**.

4. After logging into your Hydrolink Home™ account, tap **Connect** to add a device, then **Setup Device**.

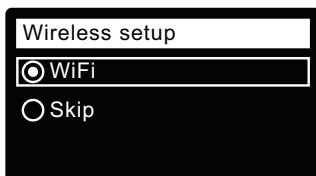
**SETUP PROCEDURE**

When the controller is plugged in for the first time (or after the model code is changed), a beep sounds and the display briefly shows a logo, followed by model information. Next, a series of “wizard” screens prompts you to enter basic operating information:



**FIG. 12**

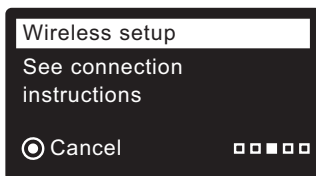
1. **LANGUAGE** If the desired language already has a dot next to it (See Figure 12), go to Step 2. Otherwise, press the filter’s DOWN (▼) or UP (▲) buttons to scroll to the desired language, then press the SELECT (○) button to choose it.
2. Press the SELECT (○) button to advance to the next “wizard” screen.



**FIG. 13**

**NOTE:** Before starting Wireless Setup, download the **EcoWater Hydrolink Home™** app from the App Store (iOS) or Google Play (Android), create an account, and log in.

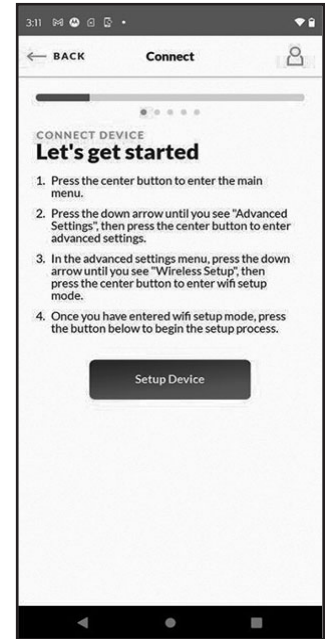
3. **WIRELESS SETUP** Use the SELECT (○) button to choose **WiFi**. The filter display will change to show “See connection instructions”.



**FIG. 14**

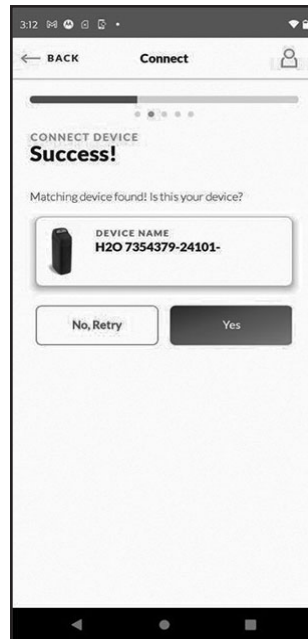


**FIG. 15**



**FIG. 16**

5. Once the device is found, tap **Yes** to set up the device and begin connecting to WiFi.



**FIG. 17**

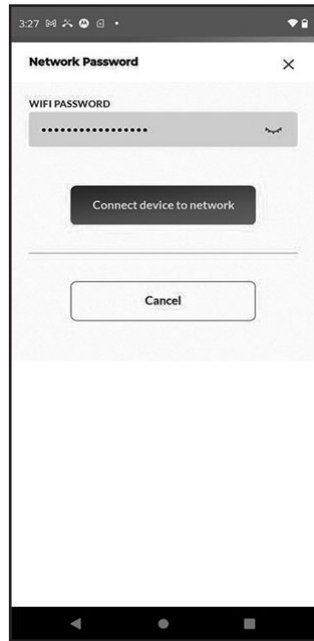


**FIG. 18**

6. Select the home's wireless network and enter the WiFi password, then tap **Connect device to network**.



**FIG. 19**

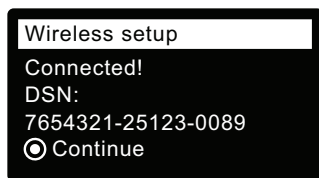


**FIG. 20**

7. When the device successfully connects to the network, you'll hear a beep and see the following message on the app. Tap the button to continue.



**FIG. 21**



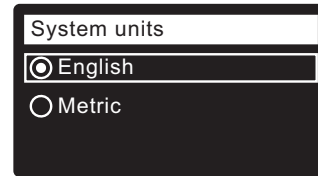
**FIG. 22**

From here, you can continue customizing your settings, or choose to skip and configure later.

**NEW WI-FI ROUTER?**

If you replace your local Wi-Fi router, a previously connected system will not automatically connect to the new router. From the **Main menu**, scroll down to the **Advanced settings** menu, select **Wireless setup**, and repeat the above wireless setup procedure to connect your system to the new router.

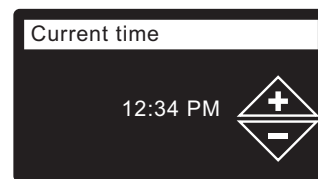
8. Press the SELECT (O) button. The filter display will change to show the next "wizard" screen.



**FIG. 23**

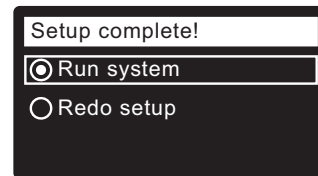
9. **SYSTEM UNITS** If the desired system already has a dot next to it (See Figure 23), go to Step 10. Otherwise, press the DOWN (▼) or UP (▲) buttons to scroll to the desired system, then press the SELECT (O) button to choose it.

10. Press the SELECT (O) button.



**FIG. 24**

11. **CURRENT TIME** Press the DOWN (▼) or UP (▲) buttons to set the current time (See Figure 24). Hold the button down to rapidly advance. Be sure that AM or PM is correct. If the system units were set to metric in Step 9, the clock will be in 24-hour format.
12. Press the SELECT (O) button. The screen will show "Setup complete!" (See Figure 25).



**FIG. 25**

13. If, at this point, you want to go back and make changes, press the DOWN (▼) button to scroll to **Redo setup**, then press the SELECT (O) button twice to repeat the "wizard" screens.
14. If no changes are desired, make sure **Run system** has a dot next to it (See Figure 25) and press the SELECT (O) button. The unit begins normal operation.

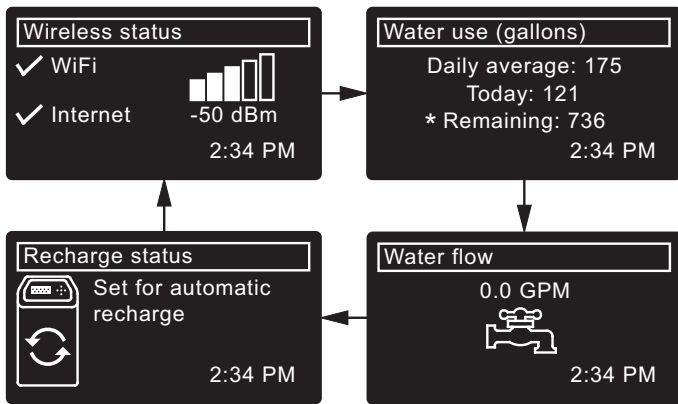
**NORMAL OPERATION**

**FILTER STATUS SCREENS**

During normal operation, the EcoWater Systems Central Water Filtration System’s display shows up to four status screens. Page 18 explains how individual screens can be turned on or off. Each is shown for six seconds, in a rolling sequence (See Figure 26).

On the “Wireless status” screen, the check marks indicate the following:

- ✓ **WiFi** - The filter is connected to a Wi-Fi router.
- ✓ **Internet** - The filter is connected to a Wi-Fi router which is connected to the internet.



\*Water remaining before the next recharge. **FIG. 26**

Pressing the filter’s RIGHT (▶) button manually advances to the next screen in the sequence. Pressing the LEFT (◀) button manually returns to the previous status screen. If no buttons are pressed for 30 seconds, the automatic rolling sequence resumes.

If **Recharge off** has been selected, as described on page 17, the rolling sequence will stop at the “Recharge status” screen.

**OTHER MESSAGES, ALERTS & REMINDERS**

The filter status screens described in the previous section will not be displayed in a rolling sequence when one of the following items is displayed:

- **Recharge status** (Displayed during recharges, showing valve position and time remaining)
- **Recharge status: Off - no automatic recharges** instead of rolling screens indicates that automatic recharges have been turned off (See Page 17).
- **Current time** setting screen instead of status screens indicates time has been lost, perhaps after a long power loss. Set the time (See next page).
- **Service reminder** (See Page 24)
- **Error detected** (Contact your dealer for service)

**FLASHING DISPLAY**

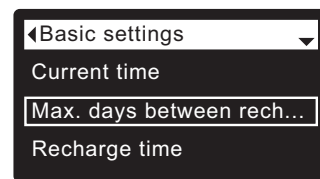
The filter’s display will flash on and off when one or more of the following conditions occurs:

- Time needs to be set (Time has been lost)
- Service is overdue (Service reminder)
- Error condition

The flashing will stop after any key is pressed. However, it will start again at Midnight if the underlying condition (e.g. time not set) has not been addressed.

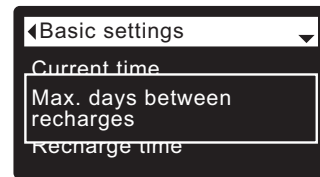
**LONG DISPLAY SCREEN MESSAGES**

Most messages in the filter’s display screens are short enough to be shown as a single line. Longer messages will be truncated (See Figure 27 for an example) until you highlight them.



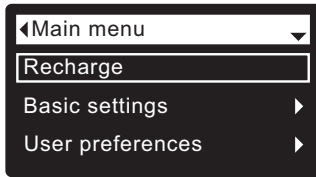
**FIG. 27**

One second after being highlighted, the viewing box expands (See Figure 28) to show the entire message. After three seconds the view resets (Figure 27).



**FIG. 28**

**MAIN MENU**



**FIG. 29**

During normal operation (status screens rolling), press the filter’s SELECT (O) button to display the Main menu (See Figure 29). This menu and its subsidiary screens are used to control these operations:

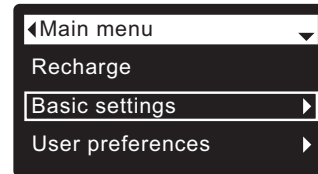
- **Recharge** (See Page 17)
- **Basic settings**
  - **Current time** (See next column)
  - **Recharge time** (See Page 18)
  - **Rolling screens** (See Page 18)
- **User preferences**
  - **Language** (See Page 19)
  - **Time format** (See Page 19)
  - **Volume units** (See Page 19)
- **System information**
  - **Model information** (See Page 20)
  - **Wireless information** (See Page 20)
  - **Water available** (See Page 20)
  - **Daily avg. water used** (See Page 20)
  - **Water used today** (See Page 20)
  - **Total water used** (See Page 20)
  - **Current water flow** (See Page 20)
  - **Days powered up** (See Page 20)
  - **Last recharge** (See Page 20)
  - **Total recharges** (See Page 20)
- **Advanced settings**
  - **Cycle times**
    - **Backwash time** (See Page 21)
    - **Fast rinse time** (See Page 21)
  - **Special features**
    - **Rinse frequency** (See Page 22)
    - **Auxiliary control** (See Page 23)
    - **Chemical feed volume\*\*** (See Page 23)
    - **Chemical feed timer\*\*** (See Page 23)
    - **Water to drain sensor** (See Page 22)
    - **Service reminder** (See Page 24)
  - **Troubleshooting**
    - **Diagnostics** (See Page 24)
    - **Setup changes** (See Page 25)
  - **Wireless setup** (See Pages 12 & 13)

\*\*Only displayed if Auxiliary control is set to Chemical feed.

**SETTING THE CURRENT TIME**

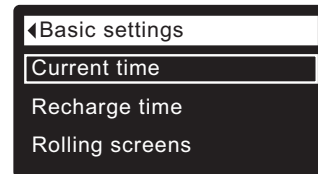
When the filter’s electronic control is first powered up, a “wizard” screen prompts you to set the current time (See Pages 12 & 13). To change the time at a later date, such as after a long power loss:

1. From any of the rolling status screens, press the SELECT (O) button to display the **Main menu**.
2. Press the DOWN (▼) button to scroll through the menu options until **Basic settings** is highlighted (See Figure 30).



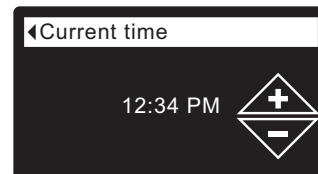
**FIG. 30**

3. Press the SELECT (O) button to display the Basic settings menu (See Figure 31).



**FIG. 31**

4. Make sure **Current time** is highlighted.
5. Press the SELECT (O) button to display the Current time screen (See Figure 32).



**FIG. 32**

6. Press the UP (▲) or DOWN (▼) buttons to change the time. Hold the button down to rapidly advance. Be sure that AM or PM is correct (unless filter is set for a 24-hour clock).
7. Press the SELECT (O) button. The display will go back to the Basic settings menu (Figure 31).
8. Press the LEFT (◀) button twice to return to the rolling status screens.

**NOTE:** On Wi-Fi connected systems, the current time will be updated and maintained automatically via Wi-Fi.

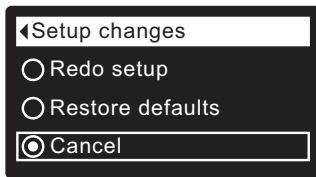
**LOCKOUT FEATURE**

A “lockout” feature is available to prevent user modification of parameters that affect filter performance. The unit is shipped from the factory with the lockout feature off. After programming is complete, the lockout feature can be turned on to prevent changes to the following:

- Backwash time
- Fast rinse time
- Rinse frequency
- Auxiliary control
- Chemical feed volume
- Chemical feed timer
- Water to drain sensor
- Service reminder
- Setup changes

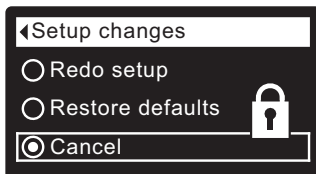
**To turn on the lockout feature:**

1. From any of the rolling status screens, press the SELECT (O) button to display the **Main menu**.
2. Press the DOWN (▼) button to scroll through the menu options until **Advanced settings** is highlighted.
3. Press the SELECT (O) button to display the Advanced settings menu.
4. Press the DOWN (▼) button to scroll through the menu options until **Troubleshooting** is highlighted.
5. Press the SELECT (O) button to display the Troubleshooting menu.
6. Press the DOWN (▼) button to scroll through the menu options until **Setup changes** is highlighted.
7. Press the SELECT (O) button to display the Setup changes menu (See Figure 33).



**FIG. 33**

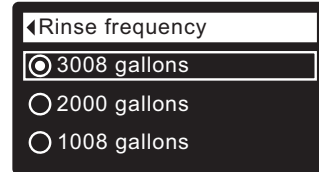
8. Press the RIGHT (▶) button. A flashing padlock icon will appear, as shown in Figure 34.



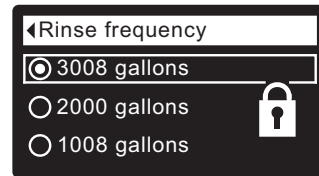
**FIG. 34**

9. Press the SELECT (O) button.
10. Press the LEFT (◀) button three times to return to the rolling status screens.

When the lockout feature is on, the flashing padlock icon will appear in any screen that would normally be used to change a parameter in the list to the left. For example, the **Rinse frequency** screen will look like Figure 36, instead of Figure 35.

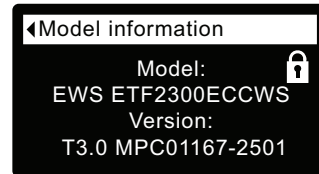


**FIG. 35**



**FIG. 36**

Another indicator that the lockout feature is on is the **Model Information** screen. This screen appears on power-up, and can also be displayed from the System Information menu (See Page 20). If the lockout feature is on, there will be a non-flashing padlock icon in the upper right corner (See Figure 37).



**FIG. 37**

**To turn off the lockout feature:**

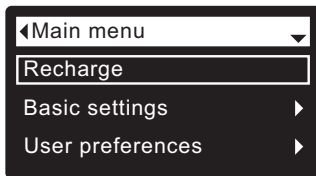
- 1-7. Go to the **Setup changes** screen (Figure 34) by following Steps 1-7 at left.
8. Press the RIGHT (▶) button. The flashing padlock icon will disappear, as shown in Figure 33.
9. Press the SELECT (O) button.
10. Press the LEFT (◀) button three times to return to the rolling status screens.



## RECHARGING THE FILTER

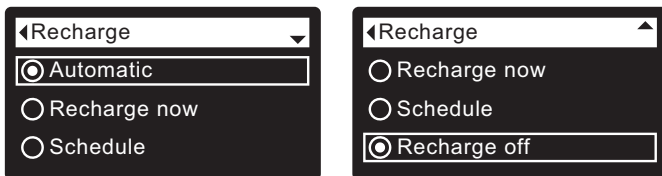
This feature may be used to assure an adequate supply of conditioned water at times of unusually high water use. For example, if you have guests you could deplete conditioned water capacity before the next automatic recharge. Initiating a manual recharge will restore 100% conditioned water capacity after complete.

1. From any of the rolling status screens, press the SELECT (O) button to display the **Main menu**.



**FIG. 38**

2. Make sure **Recharge** is highlighted (See Figure 38).
3. Press the SELECT (O) button to display the Recharge menu (See Figure 39).



**FIG. 39**

4. If the desired option already has a dot next to it (See Figure 39), go to Step 5. Otherwise, press the DOWN (▼) or UP (▲) buttons to scroll to the desired option, then press SELECT (O) to choose it.

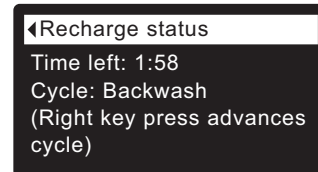
- **Automatic** cancels a manually scheduled recharge (if it has not already begun) and lets the electronic control determine when to recharge next.

- **Recharge now** begins a recharge immediately after the SELECT (O) button is pushed again in Step 5.

- **Schedule** sets a recharge to begin at the preset recharge time (set according to the instructions on Page 18).

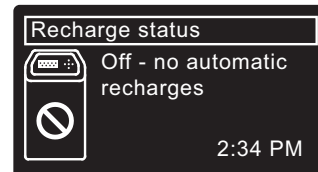
- **Recharge off** puts the system into a “vacation mode” where there will be no automatic recharges. This can be used during any long absence when you do not want the system using water. The recharge status screen will display “No automatic recharges”. When you return, be sure to cancel **Recharge off** by setting recharge to **Automatic** or **Schedule**. Initiating **Recharge now** does not cancel **Recharge off**.

5. Press the SELECT (O) button. If **Recharge now** is selected, the display immediately goes to the Recharge status screen (See Figure 40). If **Automatic**, **Schedule**, or **Recharge off** are selected, the display goes back to the Main menu (Figure 38).



**FIG. 40**

6. Press the LEFT (◀) button (twice from the Recharge status screen) to return to the rolling status screens. If **Recharge off** was selected, the normal sequence of rolling screens will stop at the screen shown in Figure 41.

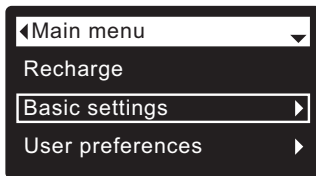


**FIG. 41**

## SETTING RECHARGE TIME

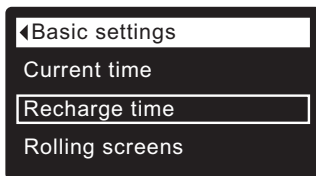
When the filter's electronic control is first powered up, the default time for starting an automatic recharge is 1:00 a.m. This is a good time in most households because water is not being used. To change this time:

1. From any of the rolling status screens, press the SELECT (O) button to display the **Main menu**.
2. Press the DOWN (▼) button to scroll through the menu options until **Basic settings** is highlighted (See Figure 42).



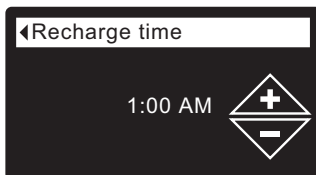
**FIG. 42**

3. Press the SELECT (O) button to display the Basic settings menu (See Figure 43).



**FIG. 43**

4. Press the DOWN (▼) button to scroll through the menu options until **Recharge time** is highlighted.
5. Press the SELECT (O) button to display the Recharge time screen (See Figure 44).



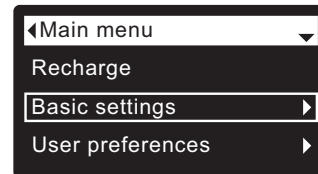
**FIG. 44**

6. Press the UP (▲) or DOWN (▼) buttons to change the recharge time in 1 hour increments. Hold the button down to rapidly advance. Be sure that AM or PM is correct (unless filter is set for a 24-hour clock).
7. Press the SELECT (O) button. The display will go back to the Basic settings menu (Figure 43).
8. Press the LEFT (◀) button twice to return to the rolling status screens.

## MODIFYING ROLLING SCREENS

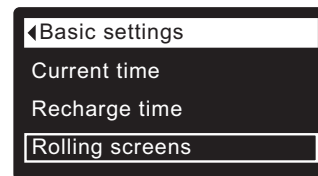
During normal filter operation, up to four status screens are shown in sequence (See "Filter Status Screens" on Page 14). When the filter's electronic control is first powered up, the default is to show all four. You can turn on/off individual screens\*:

1. From any of the rolling status screens, press the SELECT (O) button to display the **Main menu**.
2. Press the DOWN (▼) button to scroll through the menu options until **Basic settings** is highlighted (See Figure 45).



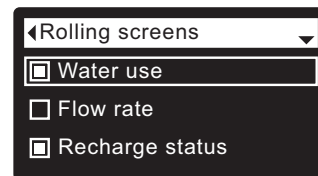
**FIG. 45**

3. Press the SELECT (O) button to display the Basic settings menu (See Figure 46).



**FIG. 46**

4. Press the DOWN (▼) button to scroll through the menu options until **Rolling screens** is highlighted.
5. Press the SELECT (O) button to display the Rolling screens menu (See Figure 147).



**FIG. 47**

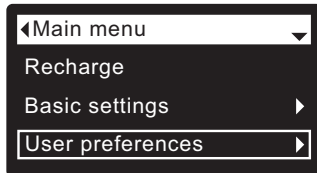
6. Press the DOWN (▼) or UP (▲) buttons to scroll through the list. Items with a black square next to them will be displayed during normal operation.
7. To un-select a screen, make sure its name is highlighted in a box. Then press the SELECT (O) button. The black square will disappear. Pressing SELECT (O) again makes the black square reappear and re-selects the highlighted item. At least one screen must be selected/highlighted.
8. When selections are complete, exit this menu by pressing the LEFT (◀) button. The display will go back to the Basic settings menu (Figure 46).
9. Press the LEFT (◀) button twice to return to the rolling status screens.

\*This does not include service reminders, errors, alerts or Recharge status screens.

## SETTING THE LANGUAGE

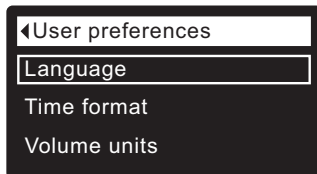
When the filter's electronic control is first powered up, a "wizard" screen prompts you to set the language (See Pages 12 & 13). To change the language:

1. From any of the rolling status screens, press the SELECT (O) button to display the **Main menu**.
2. Press the DOWN (▼) button to scroll through the menu options until **User preferences** is highlighted (See Figure 48).



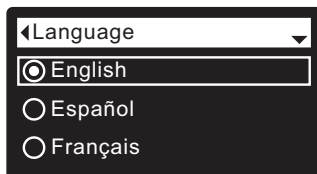
**FIG. 48**

3. Press the SELECT (O) button to display the User preferences menu (See Figure 49).



**FIG. 49**

4. Make sure **Language** is highlighted.
5. Press the SELECT (O) button to display the Language menu (See Figure 50).



**FIG. 50**

6. If the desired language already has a dot next to it (See Figure 50), go to Step 7. Otherwise, press the DOWN (▼) or UP (▲) buttons to scroll to the desired language, then press SELECT (O) to choose it. The choices are: English, Spanish, French, Italian, German, Dutch, Polish, Russian, Hungarian, Turkish, Lithuanian, Greek, Romanian, Czech, Slovak, Bulgarian, Serbian or Croatian.
7. Press the SELECT (O) button. The display will go back to the User preferences menu (Figure 49).
8. Press the LEFT (◀) button twice to return to the rolling status screens.

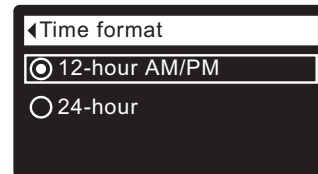
### TO SET THE FILTER TO ENGLISH IF ANOTHER LANGUAGE IS DISPLAYED:

From the rolling status screens, press SELECT (O). Press DOWN (▼) three times, then press SELECT (O) twice. Press UP (▲) to scroll to **English** at the top of the list, then press SELECT (O) twice. Press LEFT (◀) twice to exit all menus.

## SETTING TIME FORMAT

Use this feature to select a 12-hour (AM/PM) or 24-hour clock.

1. From any of the rolling status screens, press the SELECT (O) button to display the **Main menu**.
2. Press the DOWN (▼) button to scroll through the menu options until **User preferences** is highlighted.
3. Press the SELECT (O) button to display the User preferences menu.
4. Press the DOWN (▼) button to scroll through the menu options until **Time format** is highlighted.
5. Press the SELECT (O) button to display the Time format menu (See Figure 51).



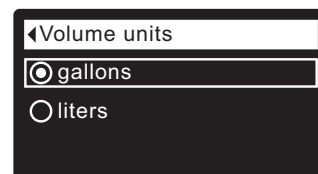
**FIG. 51**

6. If the desired time format already has a dot next to it (See Figure 51), go to Step 7. Otherwise, press the DOWN (▼) or UP (▲) buttons to scroll to the other time format, then press SELECT (O) to choose it.
7. Press the SELECT (O) button. The display will go back to the User preferences menu.
8. Press the LEFT (◀) button twice to return to the rolling status screens.

## SETTING VOLUME UNITS

Use this feature to select gallons or liters as volume units.

- 1-3. Go to the **User preferences** menu by following Steps 1-3 in "Setting Time Format" above.
4. Press the DOWN (▼) button to scroll through the menu options until **Volume units** is highlighted.
5. Press the SELECT (O) button to display the Volume units menu (See Figure 52).



**FIG. 52**

6. If the desired volume unit already has a dot next to it (See Figure 52), go to Step 7. Otherwise, press the DOWN (▼) or UP (▲) buttons to scroll to the other volume unit, then press SELECT (O) to choose it.
7. Press the SELECT (O) button. The display will go back to the User preferences menu.
8. Press the LEFT (◀) button twice to return to the rolling status screens.

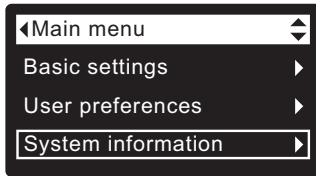
**SYSTEM INFORMATION**

Use these features to look up the following information about the filter and its operations:

- **Model information** (model number and software version)
- **Wireless information**
- **Water available** (water remaining before the next recharge)
- **Daily average water used**
- **Water used today**
- **Total water used** (explained in Step 6, below)
- **Current water flow**
- **Days powered up**
- **Last recharge**
- **Total recharges**

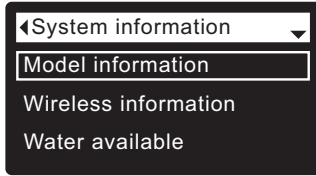
To display one of these screens:

1. From any of the rolling status screens, press the SELECT (O) button to display the **Main menu**.
2. Press the DOWN (▼) button to scroll through the menu options until **System information** is highlighted (See Figure 53).



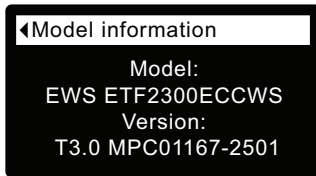
**FIG. 53**

3. Press the SELECT (O) button to display the System information menu (See Figure 54).

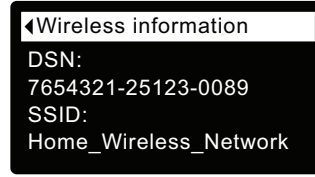


**FIG. 54**

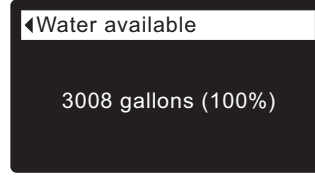
4. Press the DOWN (▼) button to scroll through the menu options until the desired option is highlighted (See list at the top of this column).
5. Press the SELECT (O) button to display the desired information screen (See Figures 55-64).
6. The **Total water used** screen (See Figure 60) shows the volume of water used since it was last reset (it works like the trip odometer in a car). To reset the value to 0, press the RIGHT (▶) button while this screen is displayed.
7. When finished viewing an information screen, press the SELECT (O) button. The display will go back to the System information menu (Figure 54). It will also exit automatically if no buttons are pressed for four minutes.
8. Press the LEFT (◀) button twice to return to the rolling status screens.



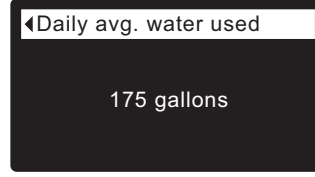
**FIG. 55**



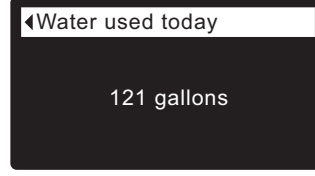
**FIG. 56**



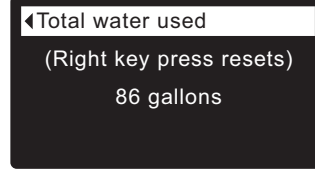
**FIG. 57**



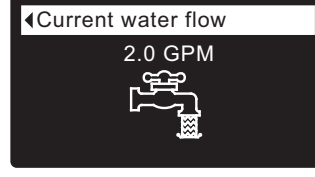
**FIG. 58**



**FIG. 59**



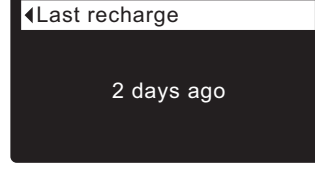
**FIG. 60**



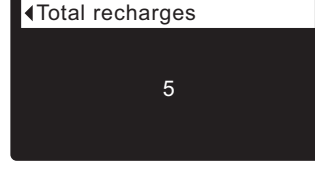
**FIG. 61**



**FIG. 62**



**FIG. 63**



**FIG. 64**

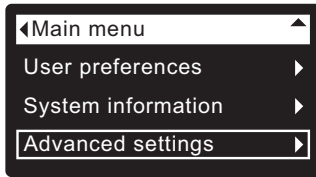
**CYCLE TIMES**

Use these features to change the following filter operations:

- **Backwash time**
- **Fast rinse time**

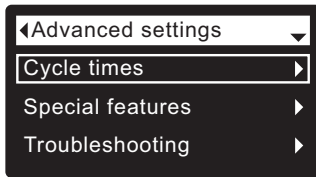
To display these screens:

1. From any of the rolling status screens, press the SELECT (O) button to display the **Main menu**.
2. Press the DOWN (▼) button to scroll through the menu options until **Advanced settings** is highlighted (See Figure 65).



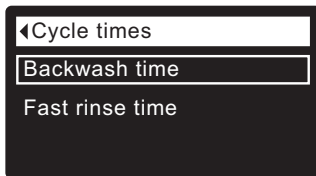
**FIG. 65**

3. Press the SELECT (O) button to display the Advanced settings menu (See Figure 66).



**FIG. 66**

4. Make sure **Cycle times** is highlighted.
5. Press the SELECT (O) button to display the Cycle times menu (See Figure 67).



**FIG. 67**

6. Press the DOWN (▼) button to scroll through the menu options until the desired option is highlighted (See list at the top of this column).
7. Press the SELECT (O) button to display the desired cycle time screen (See Figures 68 & 69).
8. **See the right column on this page for specific instructions on each cycle time screen.**
9. Press the SELECT (O) button. The display will go back to the Cycle times menu (Figure 67).
10. Press the LEFT (◀) button three times to return to the rolling status screens.

- 8a. **Backwash time:** Press the UP (▲) or DOWN (▼) buttons to change the backwash time. Hold the button down to rapidly advance. The backwash time can be set from 1 to 99 minutes\* (See Figure 68).



**FIG. 68**

- 8b. **Fast rinse time:** Press the UP (▲) or DOWN (▼) buttons to change the fast rinse time. Hold the button down to rapidly advance. The fast rinse time can be set from 1 to 99 minutes\* (See Figure 69).



**FIG. 69**

\*Reducing the backwash and fast rinse times below a filter model's default settings is not recommended.

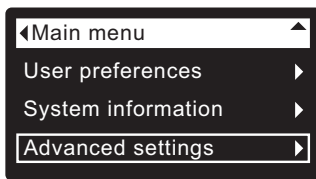
**SPECIAL FEATURES**

Use these features to change the following operations:

- **Rinse frequency**
- **Auxiliary control** (described on Page 23)
- **Chemical feed volume\*** (described on Page 23)
- **Chemical feed timer\*** (described on Page 23)
- **Water to drain sensor**
- **Service reminder** (described on Page 24)

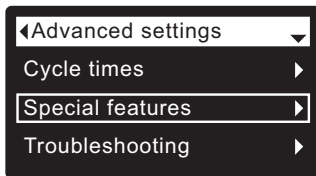
To display one these screens:

1. From any of the rolling status screens, press the SELECT (O) button to display the **Main menu**.
2. Press the DOWN (▼) button to scroll through the menu options until **Advanced settings** is highlighted (See Figure 70).



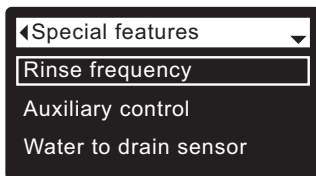
**FIG. 70**

3. Press the SELECT (O) button to display the Advanced settings menu (See Figure 71).



**FIG. 71**

4. Press the DOWN (▼) button to scroll through the menu options until **Special features** is highlighted.
5. Press the SELECT (O) button to display the Special features menu (See Figure 72).



**FIG. 72**

6. Press the DOWN (▼) button to scroll through the menu options until the desired option is highlighted (See list at the top of this column).
7. Press the SELECT (O) button to display the desired special feature screen (See Figures 73 & 74).
8. **See the right column on this page for specific instructions on each cycle time screen.**
9. Press the SELECT (O) button. The display will go back to the Special features menu (Figure 72).
10. Press the LEFT (◀) button three times to return to the rolling status screens.

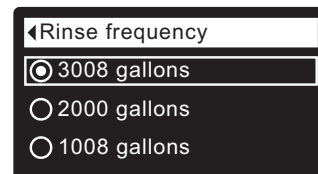
\*Only displayed if Auxiliary control is set to Chemical feed.

**8a. Rinse frequency:** The Central Water Filtration System will automatically initiate Clean Rinse cycles based on how much water has been filtered through the system. The default is to run a Clean Rinse cycle after 3008 gallons have been filtered. The clean rinse takes place at 1:00 a.m., or as set (see “Setting Recharge Time” on page 18). The system will also initiate an automatic Clean Rinse cycle if no water has been run through the system in 14 days, unless Recharge is set Off (See “Recharging the Filter” on page 17).

The frequency of automatic Clean Rinse cycles may be increased for systems where the water supply may have more sediment than in a typical municipal water supply. The table below shows the three settings available.

Water supply type	Clean Rinse every
City water supply	3008 gallons
Well water with a light amount of sediment	2000 gallons
Well water with a high amount of sediment	1008 gallons

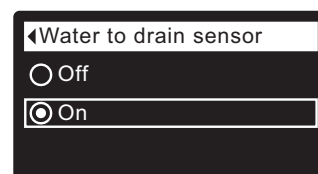
If the desired rinse frequency already has a dot next to it (See Figure 73), go to Step 9. Otherwise, press the DOWN (▼) or UP (▲) buttons to scroll to the desired rinse frequency, then press SELECT (O) to choose it.



**FIG. 73**

**8b. Water to drain sensor:** When this feature is On (the default setting), a sensor in the filter’s valve drain elbow fitting allows the electronic controller to detect whether water is continuously flowing to the drain after a recharge cycle has completed. This could indicate a possible internal valve leak. If detected, an alert will be sent via Wi-Fi, and a display screen will ask whether there is actually water flowing to the drain. Answering No will reset the water to drain sensor.

If the desired option already has a dot next to it (See Figure 74), go to Step 9. Otherwise, press the DOWN (▼) or UP (▲) buttons to scroll to the other option, then press SELECT (O) to choose it.



**FIG. 74**

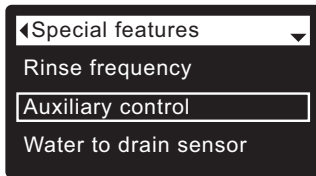
**AUXILIARY CONTROL**

The electronic control has an auxiliary output which can control external devices in a water treatment system. The signal is 24V DC, current draw 500 mA maximum. The Auxiliary Output terminals are located on the electronic control board (See Schematic on Page 33).

For more details on the use of auxiliary controlled equipment in water treatment systems, consult the EcoWater Systems “Problem Water Guide.”

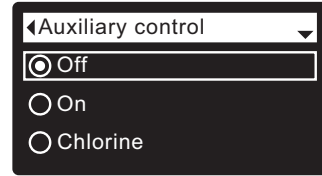
To select an auxiliary control mode:

1. From any of the rolling status screens, press the SELECT (O) button to display the **Main menu**.
2. Press the DOWN (▼) button to scroll through the menu options until **Advanced settings** is highlighted.
3. Press the SELECT (O) button to display the Advanced settings menu.
4. Press the DOWN (▼) button to scroll through the menu options until **Special features** is highlighted.
5. Press the SELECT (O) button to display the Special features menu (See Figure 75).



**FIG. 75**

6. Press the DOWN (▼) button to scroll through the menu options until **Auxiliary control** is highlighted.
7. Press the SELECT (O) button to display the Auxiliary control menu (See Figure 76).
8. If the desired option already has a black dot next to it (See Figure 76), go to Step 9. Otherwise, press the DOWN (▼) or UP (▲) buttons to scroll to the desired option, then press SELECT (O) to choose it.
  - **Off** is the default. The 24V DC output is always off.
  - **On**: The 24V DC output is always on.
  - **Chlorine** can be used to drive a chlorine generator, which produces chlorine, as water passes through it, to sanitize the media during recharges.
  - **Bypass**: Turns 24V DC on during the entire regeneration cycle (when the filter’s valve is in bypass and unfiltered is going to the house).
  - **Chemical feed**: Can be used to run a chemical feed pump. If chosen, the chemical feed volume and timer must be set, as detailed at right.
  - **Water use**: Turns 24V DC on when the filter’s turbine indicates water flow. Could drive an air pump for iron or sulfur oxidation.
  - **Fast Rinse**: Turns 24V DC on during the fast rinse portion of the regeneration cycle.
9. Press the SELECT (O) button. The display will go back to the Special features menu (Figure 75).
10. Press the LEFT (◀) button three times to return to the rolling status screens.



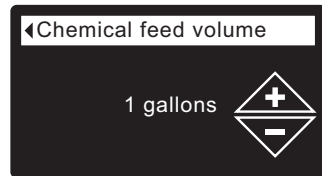
**FIG. 76**

**CHEMICAL FEED**

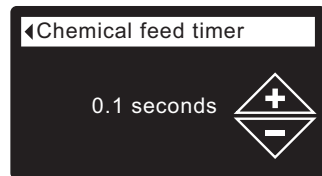
If the auxiliary control mode has been set to **Chemical feed**, as described in the previous section, two additional lines (**Chemical feed volume** and **Chemical feed timer**) will appear on the Special features menu.

To set these values:

1. From any of the rolling status screens, press the SELECT (O) button to display the **Main menu**.
2. Press the DOWN (▼) button to scroll through the menu options until **Advanced settings** is highlighted.
3. Press the SELECT (O) button to display the Advanced settings menu.
4. Press the DOWN (▼) button to scroll through the menu options until **Special features** is highlighted.
5. Press the SELECT (O) button to display the Special features menu (See Figure 75).
6. Press the DOWN (▼) button to scroll through the menu options until **Chemical feed volume** or **Chemical feed timer** is highlighted.
7. Press the SELECT (O) button to display the Chemical feed volume or Chemical feed timer menu (See Figures 77 & 78).



**FIG. 77**

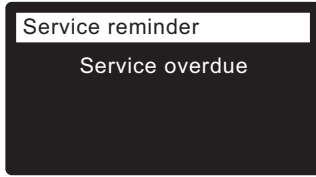


**FIG. 78**

8. Press the UP (▲) or DOWN (▼) buttons to change the value. Hold the button down to rapidly advance.
  - **Chemical feed volume** is the amount of water which will pass through the filter between each activation of the chemical feed equipment.
  - **Chemical feed timer** is how long the output to the chemical feed equipment is energized each time it is activated.
9. Press the SELECT (O) button. The display will go back to the Special features menu (Figure 75).
10. Press the LEFT (◀) button three times to return to the rolling status screens.

**SERVICE REMINDER (set / reset)**

Use this feature to program the number of months (up to 24) before a “Service overdue” message will appear instead of the rolling status screens (See Figure 79).

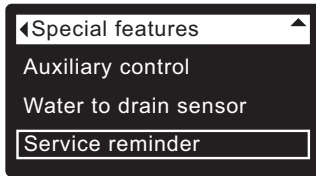


**FIG. 79**

This will be a reminder to call your dealer for service. Once programmed, this feature displays the number of months and days left until the service reminder.

Once the “Service overdue” message has appeared, dealers performing service clear it by setting the number of months until the next service reminder. Set or reset the service reminder as follows:

1. From any of the rolling status screens, press the SELECT (O) button to display the **Main menu**.
2. Press the DOWN (▼) button to scroll through the menu options until **Advanced settings** is highlighted.
3. Press the SELECT (O) button to display the Advanced settings menu.
4. Press the DOWN (▼) button to scroll through the menu options until **Special features** is highlighted.
5. Press the SELECT (O) button to display the Special features menu (See Figure 80).



**FIG. 80**

6. Press the DOWN (▼) button to scroll through the menu options until **Service reminder** is highlighted.
7. Press the SELECT (O) button to display the Service reminder screen (See Figure 81).



**FIG. 81**

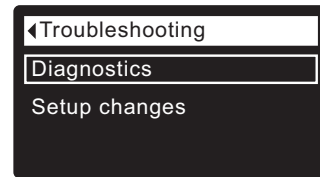
8. Press the UP (▲) or DOWN (▼) buttons to set the number of months until the service reminder appears. Repeatedly pressing the DOWN (▼) button until the display reads “Off” turns this feature off and zeros the number of months and days.
9. Press the SELECT (O) button. The display will go back to the Special features menu (Figure 80).
10. Press the LEFT (◀) button three times to return to the rolling status screens.

**DIAGNOSTICS**

This feature allows a service technician to check the operating state of individual components in the filter (e.g. valve position) to troubleshoot problems. **If an error code is displayed in place of the rolling status screens, call your dealer for service.**

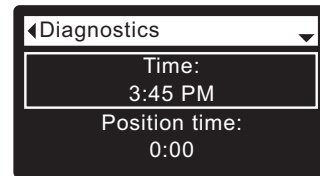
To view the Diagnostics screen:

1. If an error code is displayed, skip Steps 2-7 and go directly to Step 8.
2. To display the Diagnostics screen from any of the rolling status screens (when an error code is not displayed), press the SELECT (O) button to display the **Main menu**.
3. Press the DOWN (▼) button to scroll through the menu options until **Advanced settings** is highlighted.
4. Press the SELECT (O) button to display the Advanced settings menu.
5. Press the DOWN (▼) button to scroll through the menu options until **Troubleshooting** is highlighted.
6. Press the SELECT (O) button to display the Troubleshooting menu (See Figure 82).



**FIG. 82**

7. Make sure **Diagnostics** is highlighted.
8. Press the SELECT (O) button to display the Diagnostics screen (See Figure 83).



**FIG. 83**

9. Press the DOWN (▼) or UP (▲) buttons to scroll through the list. The following items are displayed:
  - **Time** (current)
  - **Position time** (counts down the time remaining in the current valve position)
  - **Current position** (of the valve: service, fill, brine, backwash, fast rinse or moving)
  - **Requested position** (of the valve)
  - **Motor state** (on or off)
  - **Valve position switch** (open or closed)
  - **Turbine count** (if changing, indicates water flow)
  - **Drain TDS** (total dissolved solids in ppm)
  - **Drain temperature** (°C)
  - **Tank light switch** (open or closed)
  - **RF module** (detected or not)
  - **Error code** (call for service if a number is displayed)

continued

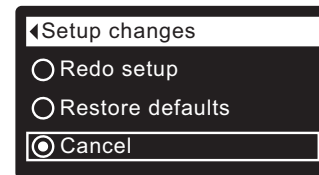


10. When finished viewing the Diagnostics screen, press the SELECT (O) button. The display will go back to the Troubleshooting menu.
11. Press the LEFT (◀) button three times to return to the rolling status screens (or error code screen if an error condition exists).

## SETUP CHANGES

This feature allows a service technician to repeat the setup procedure (See Pages 12 & 13) or restore the filter's default operating values.

1. From any of the rolling status screens, press the SELECT (O) button to display the **Main menu**.
2. Press the DOWN (▼) button to scroll through the menu options until **Advanced settings** is highlighted.
3. Press the SELECT (O) button to display the Advanced settings menu.
4. Press the DOWN (▼) button to scroll through the menu options until **Troubleshooting** is highlighted.
5. Press the SELECT (O) button to display the Troubleshooting menu (See Figure 82).
6. Press the DOWN (▼) button to scroll through the menu options until **Setup changes** is highlighted.
7. Press the SELECT (O) button to display the Setup changes menu (See Figure 84).



**FIG. 84**

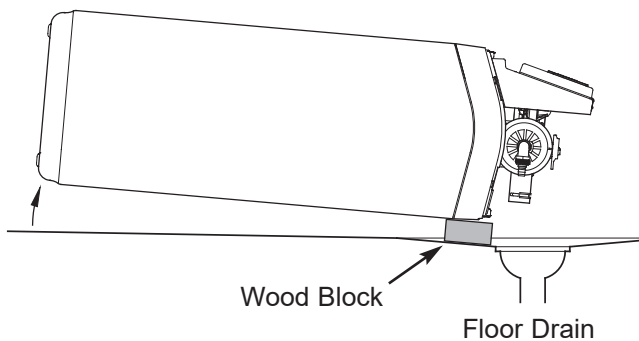
8. If the desired option already has a dot next to it (See Figure 84), go to Step 9. Otherwise, press the DOWN (▼) or UP (▲) buttons to scroll to the desired option, then press SELECT (O) to choose it.
  - **Redo setup** allows you to select a different model code (intended to be used for upgrades or retrofits of existing filters). Model codes are listed on Page 4.
  - **Restore defaults** will reset all customizable settings to their default values and take you through the “wizard” screen setup procedure (See Pages 12 & 13).
  - **Cancel** will return to the Troubleshooting menu (Figure 82).
9. Press the SELECT (O) button.

**VACATIONS AND EXTENDED PERIODS OF NO WATER USE**

If your Central Water Filtration System will not be used for an extended period of time (several months), please follow one of these recommendations:

- If the water supply to the unit is not turned off, and the automatic Clean Rinse function has not been disabled, then no further actions are required. The Central Water Filtration System will clean itself every 14 days if no water has run through it.
- If you do not want Clean Rinse cycle to be running automatically while you are gone, it is recommended that you unplug the Central Water Filtration System and either shut off the water supply or place the bypass valve(s) into the bypass position.
- If the Clean Rinse cycle cannot be automatically run, due to the water supply being shut off, the power supply being unplugged or the automatic Clean Rinse function being disabled, then it is recommended that a minimum of 2 manually initiated Clean Rinse cycles (**Recharge now**) be performed when the system is placed back into operation (see Page 17).
- In any installation where there is a possibility of freezing, the Central Water Filtration System should be disconnected and the water drained (see Protect the Central Water Filtration System from Freezing section).

**DRAIN ALL WATER FROM CENTRAL WATER FILTRATION SYSTEM**



**FIG. 85**

**PROTECT THE CENTRAL WATER FILTRATION SYSTEM FROM FREEZING**

If the Central Water Filtration System is installed where it could freeze (summer cottage, lake home, etc.), you must drain all water from it to stop possible freeze damage. If the system freezes, cracks may develop in plastic parts, which will leak causing damage.

To drain the unit:

1. Close the shut-off valve on the house main water pipe, near the water meter or pressure tank.
2. Open a faucet in the filtered water pipes to vent pressure in the unit.
3. Move the stem in the single bypass valve to bypass. Close the inlet and outlet valve in a 3 valve bypass system, and open the bypass valve. If you want water in the house pipes again, reopen the shut-off valve on the main water pipe.
4. Unplug the power supply at the wall outlet. Take off the drain hose if it will interfere with moving the Central Water Filtration System into position over the drain.
5. Remove the large holding clips at the Central Water Filtration System inlet and outlet (See Figures 7A & 7B on Page 8). Separate the unit from the copper tubes, or from the bypass valve.
6. Lay a piece of 2 inch thick board near the floor drain (See Figure 85).
7. Move the Central Water Filtration System close to the drain. Slowly and gently, tip it over until the rim rests on the wood block with the inlet and outlet over the drain (See Figure 85). Do not allow the unit's weight to rest on the inlet and outlet fittings or they may break.
8. Tip the bottom of the Central Water Filtration System up a few inches and rest it on something like a wood block that will allow water to drain. Rest the bottom on two stacked wood blocks. Leave the unit laying like this until you are ready to use it. Plug the inlet and outlet with clean rags to keep dirt, bugs, etc. out.

## RELIEVING WATER PRESSURE WITH THE BYPASS VALVE(S)

**CAUTION:** Always relieve water pressure in the Central Water Filtration System, as described below, before removing parts from the valve or mineral tank.

### DE-PRESSURIZE

1. Put bypass valve(s) into **Bypass** position.
2. Place filter valve in **Backwash** position by pressing and holding the RECHARGE button for a few seconds to start a recharge.

### PRESSURIZE

1. Put bypass valve(s) into **Service** position.
2. Return filter valve to **Service** position by pressing the RECHARGE button several times to advance the valve through the remaining cam positions of the recharge cycle.

## ALTERNATE METHODS:

### 3-VALVE BYPASS (See Figure 86)

#### DE-PRESSURIZE

1. Close the INLET valve.
2. Open HOT and COLD filtered water house faucets.
3. Close the OUTLET valve and open the BYPASS valve.
4. Close all house faucets.

#### PRESSURIZE

1. Open HOT and COLD house faucets.
2. Close the BYPASS valve and open the OUTLET valve.
3. **Slowly**, open the INLET valve.
4. Close all house faucets.

## ECOWATER SYSTEMS BYPASS VALVE

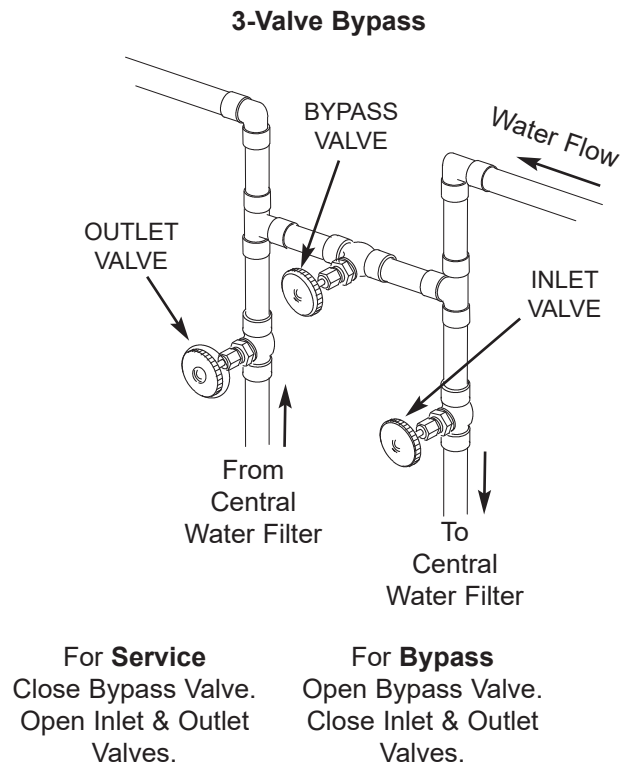
(See Figure 87)

#### DE-PRESSURIZE

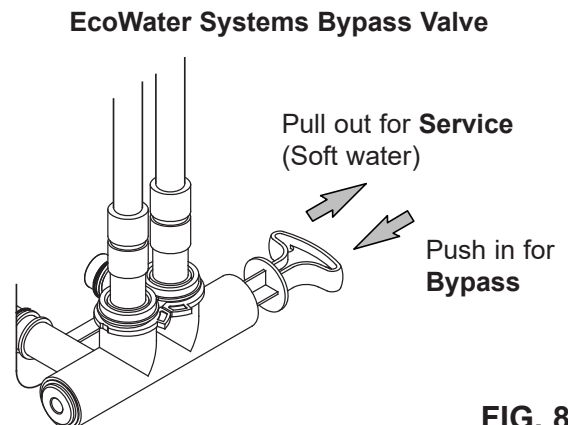
1. Close the house main water supply valve.
2. Open HOT and COLD filtered water house faucets.
3. Push the bypass valve handle to **Bypass** position.
4. Optional: For unfiltered water bypass to house faucets, reopen the main water supply valve.

#### PRESSURIZE

1. Open main water supply valve if it is closed.
2. Open HOT and COLD house faucets.
3. Pull the bypass valve handle to **Service** position.
4. Close all house faucets.



**FIG. 86**



**FIG. 87**

**TROUBLESHOOTING GUIDE**

<b>PROBLEM</b>	<b>CAUSE</b>	<b>CORRECTION</b>
<b>Water has black or gray color</b>	(NEW SYSTEM) Start up procedure has not been completed	Run start up procedure (See Page 10) or run consecutive "Recharge now" cycles (See Page 17) until water color returns to normal.
	(NOT A NEW SYSTEM) Normal abrasion of filtration media	Manually initiate a "Recharge now" cycle (See Page 17).
<b>Low water pressure at house faucets</b>	Sediment filter screen is clogged	Manually initiate a "Recharge now" cycle (See Page 17).
		If the filter screen is frequently plugging, it may be necessary to adjust the frequency of Clean Rinse cycles or add a sediment filter upstream (See Figures 2A & 2B on Page 6).
	Filtration media pores are blocked	Manually initiate a "Recharge now" cycle (See Page 17). If the filtration media pores are frequently blocking, it may be necessary to increase the frequency of Clean Rinse cycles or add a sediment filter upstream (See Figures 2A & 2B on Page 6).
<b>Water has objectionable taste and/or odor</b>	System is in bypass	Move bypass valve(s) to normal operating (non-bypass) position.
	Filtration media pores are blocked	Manually initiate a "Recharge now" cycle (See Page 17).
		If the filtration media pores are frequently blocking, it may be necessary to increase the frequency of Clean Rinse cycles or add a sediment filter upstream (See Figures 2A & 2B on Page 6).
<b>No water flow to drain during Clean Rinse cycle</b>	System is in bypass	Move bypass valve(s) to normal operating (non-bypass) position.
	Drain flow control is plugged	Clean drain flow control (See Page 33).
	Drain hose is plugged or kinked	Straighten drain hose.
	Power supply is unplugged from wall electrical outlet (display will be blank)	Check for loss of power and correct.
<b>Clean Rinse cycle does not run automatically</b>	If display reads "Off - no automatic recharges", then Clean Rinse function has been disabled	Go to the Recharge screen and select "Schedule" or "Automatic" (See Page 17).
	If display is blank, power supply may be unplugged from wall electrical outlet	Check for loss of power.
<b>Clean Rinse cycle does not run at the programmed time of day</b>	If time display is flashing, then a long power loss caused the clock to lose its time setting	Reset the clock to the correct time of day (See Page 15).
<b>Valve motor stalled or clicking</b>	Motor is defective or inner valve defect is causing high torque on the motor	Replace rotor/seal kit (instructions included with kit).
		Replace motor and switch (See parts list at end of this manual).

**TROUBLESHOOTING GUIDE (cont.)**

<b>PROBLEM</b>	<b>CAUSE</b>	<b>CORRECTION</b>
<i>“Off - no automatic recharges” is shown in the display</i>	The automatic Clean Rinse function has been disabled (See Page 17)	If you want the Clean Rinse function to run automatically, go to the Recharge screen and select “Schedule” or “Automatic” (See Page 17).
<i>Error Code E1, E3 or E4 appears</i>	Wiring harness or connections to position switch	Replace wiring harness or connection to position switch (See parts list at end of this manual).
	Switch	Replace switch (See parts list at end of this manual).
	Valve defect causing high torque	Replace rotor/seal kit (instructions included with kit).
	Motor inoperative	Replace motor (instructions included with motor)
<i>Error Code E5 appears</i>	Electronic control	Replace electronic control board (PWA) (instructions included with PWA).

**Procedure for removing error code from display:**

1. Unplug power supply from electrical outlet.
2. Correct problem.
3. Plug power supply back in.
4. Wait 8 minutes. The error code will return if the problem was not corrected.

**Assistance from customer service may be needed with the following:**

<b>PROBLEM</b>	<b>CAUSE</b>	<b>CORRECTION</b>
<i>Water running to the drain (while unit is not in the Clean Rinse cycle)</i>	Inner valve defect causing leak	Replace seals and rotor
<i>Filter media in household plumbing</i>	Crack in distributor or riser tube	Replace distributor or riser tube.

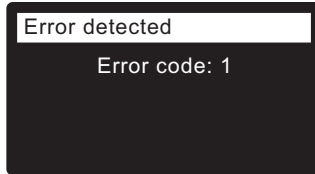
**TROUBLESHOOTING - INITIAL CHECKS**

**Always make these initial checks first:**

1. Is display blank? Check power source.
  2. Is Error code displayed? If so, go to “Automatic Electronic Diagnostics” on the next page.
  3. Is correct time displayed? If not, recharges occur at the wrong time. Set current time (See Page 15.)
  4. Are plumbing bypass valve(s) in service position (See Figures 86 & 87 on Page 27)?
  5. Are inlet and outlet pipes connected to the Central Water Filtration System inlet and outlet respectively?
  6. Is valve drain hose free of kinks and sharp bends, and not elevated over 8 feet above the floor.
- If no problem is found after making the initial checks, proceed to “Troubleshooting - Manual Diagnostics” and “Manual Advance Recharge Check” on the next two pages.

## AUTOMATIC ELECTRONIC DIAGNOSTICS

This filter has a self-diagnostic function for the electrical system (except for input power and/or water meter). The controller monitors electronic components and circuits for correct operation. If a malfunction occurs, an **Error code** is displayed (See Figure 88).



**FIG. 88**

The troubleshooting chart on the previous two pages shows the error codes that could appear, and the possible malfunctions for these codes.

When an error code appears in the display, pressing SELECT (O) will display the **Diagnostics** screen (See Page 24), so a service technician can further isolate the problem.

## REMOVING ERROR CODE

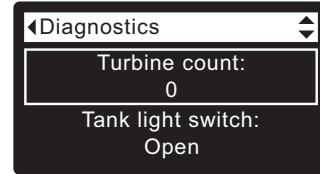
1. Unplug power supply from electrical outlet.
2. Correct problem.
3. Plug power supply back in.
4. Wait for eight minutes while controller operates valve through an entire cycle. The error code will return if the problem was not corrected.

## TROUBLESHOOTING - MANUAL DIAGNOSTICS

1. Display the **Diagnostics** screen, following the procedure on Page 24.
2. Press the DOWN (▼) or UP (▲) buttons to scroll through the list. The following items are displayed:
  - **Time** (current)
  - **Position time** (counts down the time remaining in the current valve position)
  - **Current position** (of the valve: service, fill, brine, backwash, fast rinse or moving) See “Manual Advance Recharge Check” on the next page for position verification.
  - **Requested position** (of the valve)
  - **Motor state** (on or off)
  - **Valve position switch** (open or closed)
  - **Turbine count** (if changing, indicates water flow) See following section for turbine diagnostics.
  - **Drain TDS** (in parts per million)
  - **Drain temperature** (in degrees Celsius)
  - **Tank light switch** (open or closed)
  - **RF module** (detected or not)
  - **Error code**

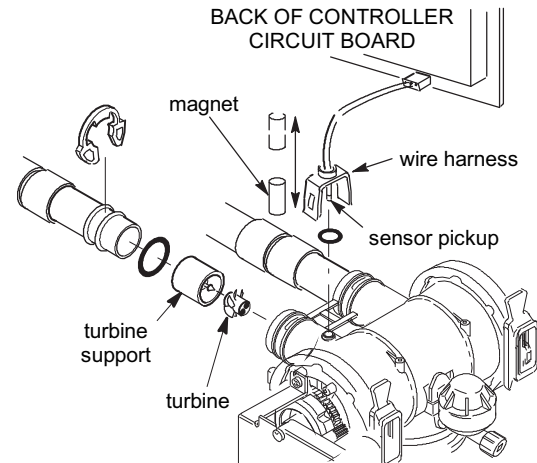
## CHECKING THE TURBINE

1. Display the **Diagnostics** screen, following the procedure on Page 24.
2. Press the DOWN (▼) button to scroll through the list until **Turbine Count** is displayed (See Figure 89).



**FIG. 89**

3. A steady display of “0” (zero) indicates no water flow through the meter (i.e. no conditioned water being used).
4. Open a nearby conditioned water faucet.
5. The number in the display should count upward from 0 and reset at 151 for each gallon of flow.
6. If the display reading does not change with the faucet open, pull the wire harness from the valve outlet port (See Figure 90).



**FIG. 90**

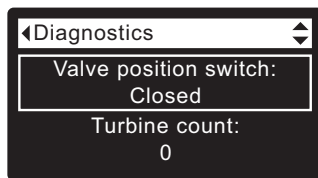
7. Pass a small magnet back and forth in front of the sensor.
- 8a. If the displayed **Turbine Count** does count upward with each pass of the magnet, disconnect the outlet plumbing and check the turbine for binding.
- 8b. If the displayed **Turbine Count** does not count upward with each pass of the magnet, the sensor is probably faulty.

**TROUBLESHOOTING -  
MANUAL ADVANCE RECHARGE CHECK**

Use the following procedures to advance the filter through the recharge cycles to check operation. Always make the Initial Checks (See Page 29) and the Manual Diagnostics (See Page 30) first.

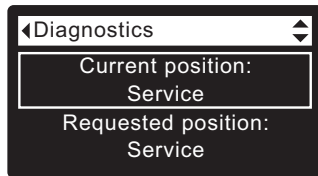
Remove the top cover by unlocking the tabs and lifting, to observe cam and switch operation during valve rotation.

1. Display the **Diagnostics** screen, following the procedure on Page 24.
2. Press the DOWN (▼) button to scroll through the list until **Valve position switch** is displayed (See Figure 91).



**FIG. 91**

3. Verify that when the switch plunger is down (into one of the detents on the valve motor cam), this screen reads **Open**. When the valve cam is rotating (for example, after Step 5, below), the switch plunger will be up and this screen should read **Closed**.
4. Press the UP (▲) button to scroll through the list until **Current position** is displayed (See Figure 92).



**FIG. 92**

5. With the Diagnostics screen displayed, press the RIGHT (▶) button once to advance the valve from **Service** to **Backwash**.
6. Verify that the valve position indicator on the motor cam agrees with the position displayed on the screen
7. Look for a fast flow of water from the drain hose. If flow is slow, check for a plugged top distributor, backwash flow plug or drain hose.
8. With the Diagnostics screen displayed, once again press the RIGHT (▶) button to advance the valve to **Fast rinse**.
9. Again, look for a fast flow of water from the drain hose.
10. With the Diagnostics screen displayed, once again press the RIGHT (▶) button to return the valve to the **Service** position.

**IMPORTANT:** Always return the valve to the **Service** position before exiting this procedure.

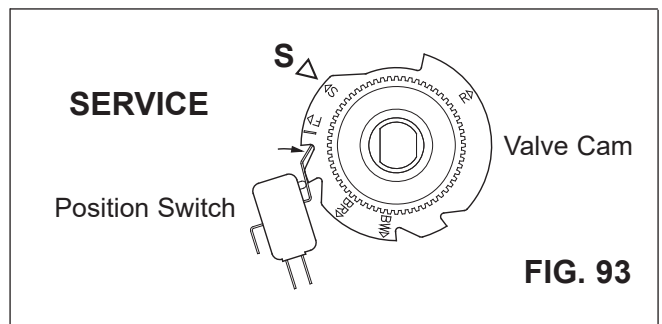
**OTHER SERVICE**

**Unfiltered Water Bypass** (Unfiltered water “bleeds” into filtered water supply):

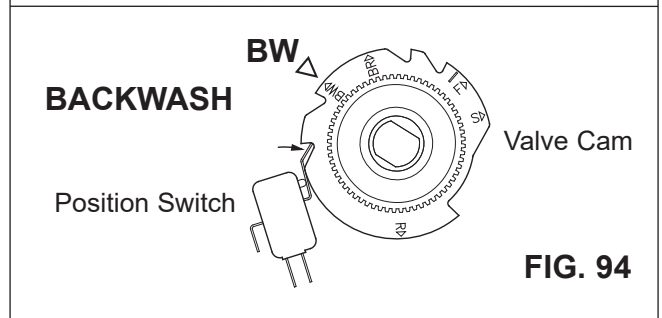
1. Faulty inlet disc, seal or wave washer (See Pages 36 & 37).
2. Missing or faulty o-ring(s) at valve connection to riser pipe.

**Water Leaks from Drain Hose** during service:

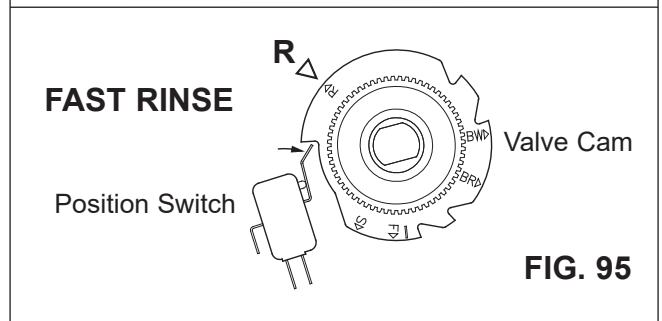
1. Faulty inlet disc, seal or wave washer.
2. Faulty o-ring on inlet disc shaft.
3. Faulty outlet disc, seal or wave washer.



**FIG. 93**



**FIG. 94**



**FIG. 95**

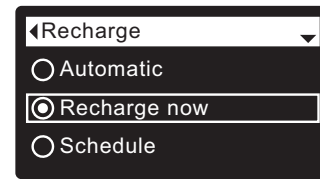
## CLEANING THE SEDIMENT FILTER SCREEN

This procedure is not required if the Central Water Filtration System is operating normally. It should be performed only if a problem with low water pressure at household faucets is encountered, as detailed in the troubleshooting table on Page 28.

1. Initiate a **Recharge now** (See Page 17).
2. When water begins to flow from the valve drain hose, place the bypass valve(s) in bypass position (See Figures 86 & 87 on Page 27).

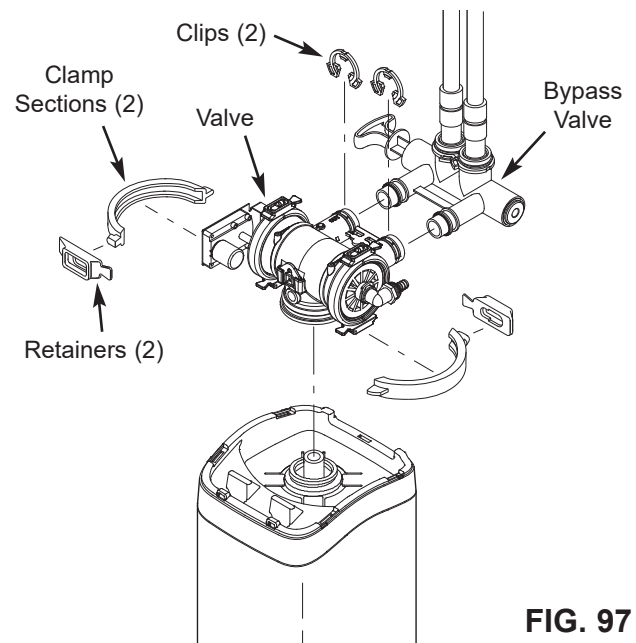
**IMPORTANT:** Be sure to do Steps 1 and 2, as instructed, to relieve water pressure in the tank.

3. Unplug the power supply from the wall electrical outlet.
4. Remove the top cover by unlocking the two tabs and lifting.
5. Pull the two clips at the inlet and outlet fittings. Slide the adaptors, or bypass valve, from the Central Water Filtration System valve.
6. Remove the clamp retainers (2) and clamp sections (2) that hold the valve to the tank (See Figure 97). Lift upward to remove the valve.
7. Remove the small o-ring (See Figure 98).
8. Remove the screen from the top distributor. Rinse off the screen.
9. Use water to flush the tank top opening. Then, replace the top distributor and o-ring. Be sure to locate o-ring seal correctly (See Figure 98).
10. Install the valve assembly and retaining clamps. Double check to be sure clamps and retainers are securely fastened in place.
11. Referring to the installation instructions, reconnect the Central Water Filtration System to the plumbing. Be sure the plumbing is held firmly in place in the valve inlet and outlet.
12. Return the plumbing bypass valve(s) to normal operating position (non-bypass).
13. Plug the power supply back into the wall electrical outlet. The Central Water Filtration System will complete the recharge cycle initiated in Step 1, and will automatically return to normal operation.



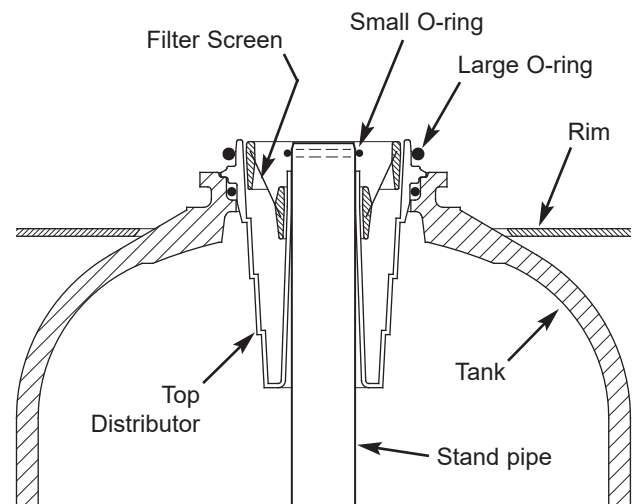
**FIG. 96**

## REMOVING VALVE ASSEMBLY



**FIG. 97**

## REASSEMBLING FILTER SCREEN



**FIG. 98**

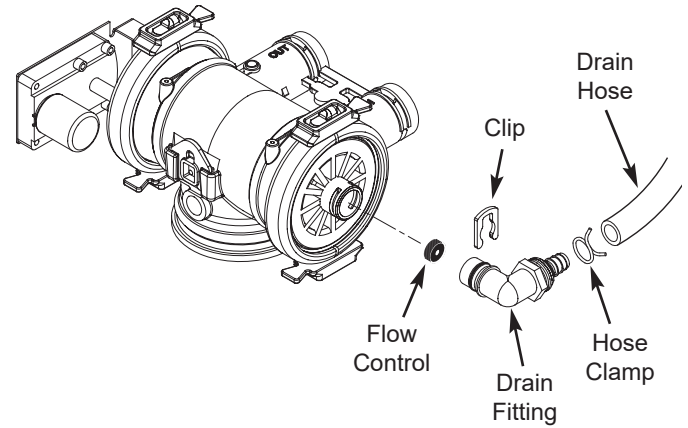


**CLEANING THE DRAIN FLOW CONTROL**

This procedure is not required if the Central Water Filtration System is operating normally. It should be performed only if a problem with lack of water flow to drain is encountered, as detailed in the troubleshooting table on Page 28.

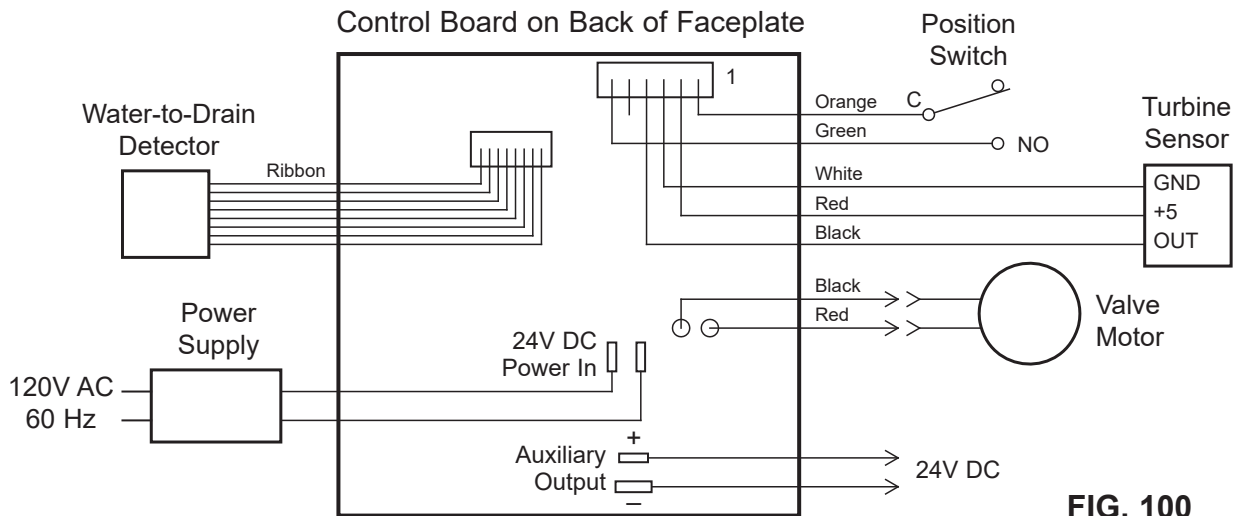
1. Remove the clip holding the drain fitting into the valve (See Figure 99).
2. Remove the drain fitting from the valve
3. Clear any obstruction.
4. Reinstall the drain fitting into the valve.
5. Reinstall the clip to secure the drain fitting in the valve.

**REMOVING DRAIN FITTING TO CLEAN FLOW CONTROL**



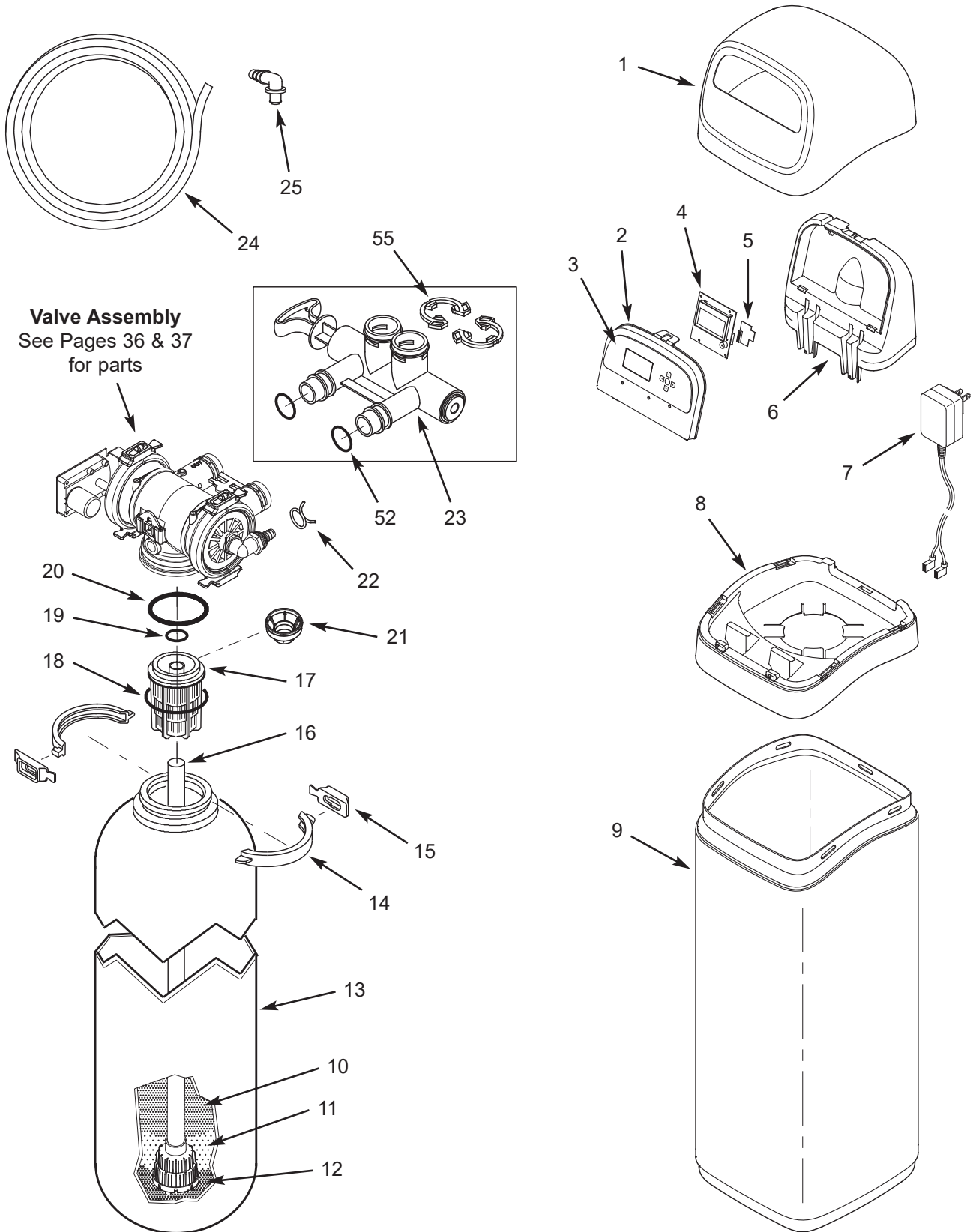
**FIG. 99**

**WIRING SCHEMATIC**



**FIG. 100**

**ECOWATER SYSTEMS CENTRAL WATER FILTER ASSEMBLY**

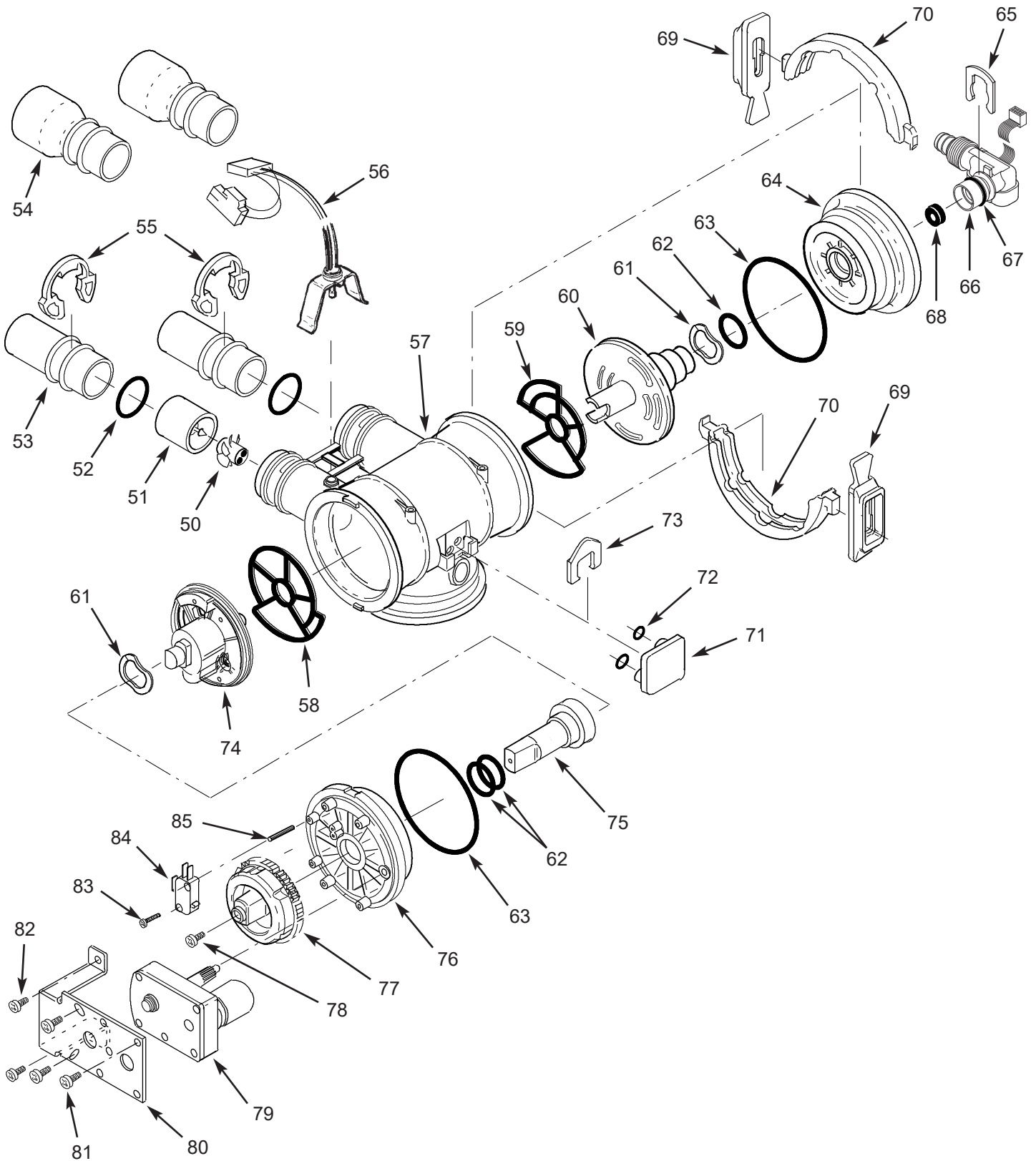


**ECOWATER SYSTEMS CENTRAL WATER FILTER ASSEMBLY**

Key No.	Part No.	Description
1	7353365	Top Cover
–	7399785	Repl. Faceplate Assembly (includes Key Nos. 2-5)
2	↑	Faceplate
3	↑	Keypad/Decal
4	↑	Electronic Controller (PWA)
5	↑	Wi-Fi Module
6	7353381	Support, Faceplate
7	7351054	Power Supply, 24V DC
8	7357539	Rim
9	7353226	Shroud
10	7339141	Catalytic Carbon, 27.5 lbs. (16 lbs. req.)
11	0501783	Filter Sand, 10 lbs. (5 lbs. req.)
12	7124415	Gravel, 17 lbs. (6 lbs. req.)
13	7304235	Repl. Mineral Tank, 8" x 35"
–	7331177	Tank Neck Clamp Kit (includes 2 ea. of Key Nos. 14 & 15)
14	↑	Clamp Section (2 req.)
15	↑	Retainer Clip (2 req.)
16	7105047	Repl. Bottom Distributor
17	7077870	Top Distributor
–	7112963	Distributor O-Ring Kit (includes Key Nos. 18-20)
18	↑	O-Ring, 2-7/8" x 3-1/4"
19	↑	O-Ring, 13/16" x 1-1/16"
20	↑	O-Ring, 2-3/4" x 3"
21	7265025	Filter Screen
22	7112882	Hose Clamp ❶
23	7214383	Bypass Valve Assembly, 1" ❶ (incl. 2 ea. of Key Nos. 52 & 55)
24	7108118	Drain Hose, 1/2" I.D. ❶
25	1103200	Adaptor Elbow ❶

❶ Not included

**VALVE ASSEMBLY**



**VALVE ASSEMBLY**

Key No.	Part No.	Description
–	7290931	Turbine & Support Assembly, including 2 O-Rings (See Key No. 52) & 1 ea. of Key Nos. 50 & 51
50	↑	Turbine
51	↑	Turbine Support & Shaft
52	7311127	O-Ring, 1-1/16" x 1-5/16", single (2 req.)
	7336410	O-Ring, 1-1/16" x 1-5/16", pack of 20
53	7077642	Copper Tube, 1", single (2 req.)
	7344138	Copper Tube, 1", pack of 10 (includes 10 ea. of Key No. 52)
54	7234553	Copper Tube, 1-1/4" pipe (optional) ❶
55	7089306	Clip, 1", single (2 req.) ❶
	7336428	Clip, 1", pack of 20 ❶
56	7309811	Wire Harness w/pos. switch conn.
57	7159949	Disc Valve Housing
58	7334133	Outlet End Seal, single ❷
	7354304	Outlet End Seal, pack of 20
59	7334125	Inlet End Seal, single ❷
	7353399	Inlet End Seal, pack of 20
–	7135270	Inlet & Outlet End Seal Kit (includes 1 ea of Key Nos. 58 & 59)
60	7390236	Inlet Disc Asm., single ❷
	7368475	Inlet Disc Asm., pack of 10
61	7058216	Wave Washer (2 req.)
62	7170220	O-Ring, 3/4" x 15/16", single (3 req.) ❷
	7336444	O-Ring, 3/4" x 15/16", pack of 30 ❷
63	7170296	O-Ring, 2-7/8" x 3-1/4", single (2 req.)
	7336452	O-Ring, 2-7/8" x 3-1/4", pack of 20

Key No.	Part No.	Description
64	7077498	Inlet End Cap
65	7142942	Clip, Drain
66	7357830	Drain Elbow Assembly w/Water-to-Drain Sensor (includes Key No. 67)
67	7170327	O-Ring, 5/8" x 13/16"
68	7097969	Flow Plug, Fast Rinse, 3.0 gpm
–	7331177	Tank Neck Clamp Kit (includes 2 ea. of Key Nos. 69 & 70)
69	↑	Retainer Clip (4 req.) ❸
70	↑	Clamp Section (4 req.) ❸
71	7100940	Plug, Aspirator Port
72	7170319	O-Ring, 1/4" x 3/8" (2 req.)
73	7081201	Clip, Nozzle & Venturi
74	7390244	Outlet Disc Asm., single ❷
	7368483	Outlet Disc Asm., pack of 10
75	7091329	Driver, Outlet Disc
76	7159965	Outlet End Cap
77	7283497	Cam & Gear
78	7203104	Washerhead Screw, #8-18 x 1/2"
79	7281275	Motor, incl. Key No. 81
80	7289702	Bracket, Motor
81	7168524	Screw, #10-32 x 5/16" (3 req.)
82	7103972	Screw, #8-18 x 7/16" (2 req.)
83	7140738	Screw, #4-24 x 3/4"
84	7145186	Switch
85	7140746	Expansion Pin

❶ Not included

❷ Included in Disc Kit, #7218688

❸ Not all parts are shown