

OWNER'S MANUAL

How to operate your EcoWater Systems Water Conditioner/Refiner

ECOWATER[®]
S Y S T E M S



Your Water. Perfected.

SERIES 3700 & 3702

HydroLink Plus[®]

Conditioners (ECR)

Refiners (ERR)

Chloramine & Chlorine Conditioner (ERRC)

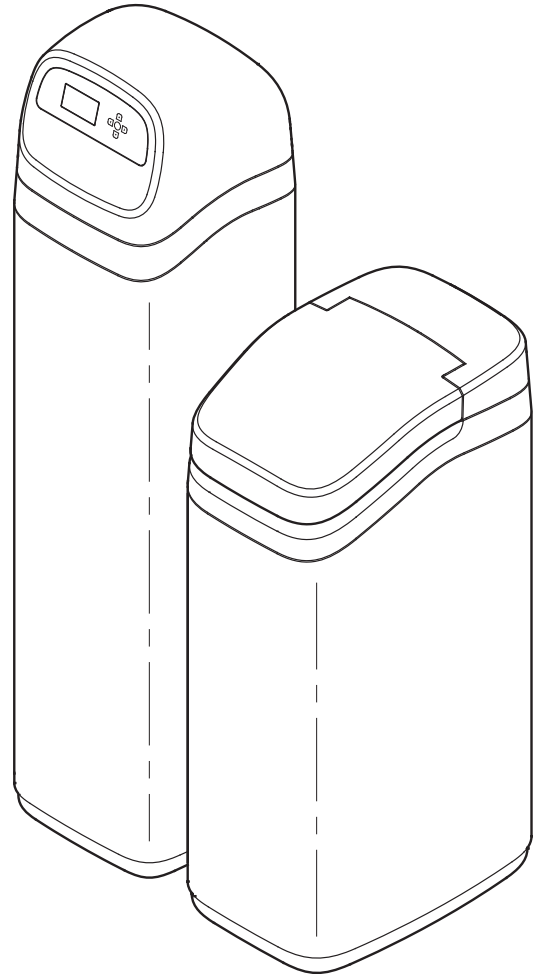
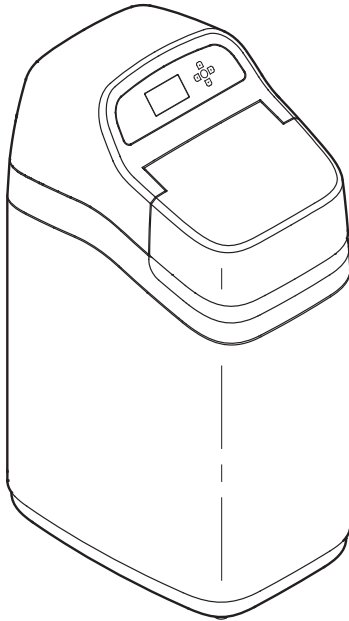

Systems tested and certified by NSF International against NSF/ANSI Standard 44 for hardness reduction and efficiency and the reduction of barium and radium 226/228, and certified to NSF/ANSI/CAN Standard 372.

ERR3700R20, ERR3702R30 & ERR3702R50 are tested and certified by NSF International against NSF/ANSI Standard 42 for chlorine taste and odor.

ERRC3702R50 has been tested and certified by NSF International to NSF/ANSI/CAN Standard 372, and is not certified for materials safety, contaminant reductions or structural integrity by NSF International.

Systems tested and certified by the Water Quality Association against CSA B483.1.



Designed, Engineered &
Assembled in the U.S.A.

EcoWater Systems LLC
P.O. Box 64420, St. Paul, MN 55164-0420
www.ecowater.com

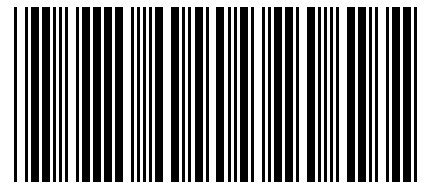

7365150 (Rev. L 10/20/23)

TABLE OF CONTENTS

	<u>Page</u>
Guarantee	3
Specifications & Performance Claims	4-5
Dimensions	6-7
Planning Installation	8
Unpacking	9
Installation	9-12
Setup Procedure	13-16
Conditioner/Refiner Operation	17-30
Service Information	31-36
Adding Salt	31
Troubleshooting Guide	34
Schematic	37
Repair Parts	38-43
Warranty	44

SAFETY GUIDES

Follow the installation instructions carefully. Failure to install the EcoWater Systems conditioner/refiner properly **voids the warranty**.

Before you begin installation, read this entire manual. Then, obtain all the materials and tools you will need to make the installation.

Check local plumbing and electrical codes. The installation must conform to them.

Use only lead-free solder and flux for all sweat-solder connections, as required by state and federal codes.

Use care when handling the EcoWater Systems conditioner/refiner. Do not turn upside down, drop, or set on sharp protrusions.

Do not locate the EcoWater Systems conditioner/refiner where freezing temperatures occur. Do not attempt to treat water over 120°F. **Freezing, or hot water damage voids the warranty.**

The EcoWater Systems conditioner/refiner requires a minimum water flow of 3 gallons per minute at the inlet.

Maximum allowable inlet water pressure is 125 psi.

If daytime pressure is over 80 psi, nighttime pressure may exceed the maximum. Use a pressure reducing valve if necessary (Adding a pressure reducing valve may reduce the flow).

The EcoWater Systems conditioner/refiner works on **24V DC** electrical power, supplied by a direct plug-in power supply (included). Be sure to use the included power supply, and plug it into a nominal **120V, 60 Hz** household outlet that is in a **dry location only**, grounded and properly protected by an over current device such as a circuit breaker or fuse.

This system is not intended to be used for treating water that is microbiologically unsafe or of unknown quality without adequate disinfection before or after the system.

If conditioner/refiner is being used to reduce barium and/or radium 226 and 228, please verify performance by contacting Legend Technical Services, an independent laboratory, at 1-800-949-8220 for testing treated water supply, or check the water testing section of your local phone directory.

FCC NOTICE

NOTE: This equipment has been tested and found to comply with the limits for a Class B digital device, pursuant to Part 15 of the **FCC** Rules. These limits are designed to provide reasonable protection against harmful interference in a residential installation. This equipment generates, uses, and can radiate radio frequency energy and, if not installed and used in accordance with the instructions may cause harmful interference to radio communications. However, there is no guarantee that interference will not occur in a particular installation. If this equipment does cause harmful interference to radio or television reception, which can be determined by turning the equipment off and on, the user is encouraged to try to correct the interference by one or more of the following measures:

- Reorient or relocate the receiving antenna.
- Increase the separation between the equipment and receiver.
- Connect the equipment into an outlet on a circuit different from that to which the receiver is connected.
- Consult the dealer or an experienced radio/TV technician for help.

Changes or modifications not expressly approved by EcoWater Systems could void the user's authority to operate the equipment.

This device complies with **Industry Canada** Standard RSS-210. Operation is subject to the following two conditions: (1) this device may not cause interference, and (2) this device must accept any interference, including interference that may cause undesired operation of the device.

Ce dispositif est conforme avec la norme CNR-210 **d'Industrie Canada**. Le fonctionnement du dispositif est sujet aux deux conditions suivantes: (1) le dispositif ne doit pas causer de brouillage, et (2) le dispositif doit accepter tous brouillages, incluant tous brouillages qui peut nuire au bon fonctionnement du dispositif.



European Directive 2002/96/EC requires all electrical and electronic equipment to be disposed of according to Waste Electrical and Electronic Equipment (WEEE) requirements. This directive or similar laws are in place nationally and can vary from region to region. Please refer to your state and local laws for proper disposal of the equipment.

Crest of Excellence

GUARANTEE

for the EcoWater Series 3700 & 3702 Water Conditioning Systems

Satisfied customers are our most valuable asset, and EcoWater has been dedicated to the manufacture of the highest quality water conditioning equipment and to the satisfaction of its customers for over 85 years. When you purchase EcoWater equipment you're buying quality; and that is exactly what we expect you to receive!

The Crest of Excellence Performance Guarantee assures you that satisfying customers is our primary concern, and allows you to feel secure and confident with the quality of your purchase.

If during the first year of installation, the unit does not perform the function for which it was designed, and the repetitive problem remains uncorrected, we will – under the Crest of Excellence Performance Guarantee and at no charge to you – replace the unit with identical equipment or with equipment of comparable features and capabilities.

The Crest of Excellence Performance Guarantee applies to new equipment which is purchased and serviced through Authorized EcoWater Dealers, and is not applicable to equipment which is damaged or destroyed by forces of nature, abuse, neglect or misuse.

It's just that easy! Quality and satisfaction are what you are buying and the Crest of Excellence Performance Guarantee is our promise that you'll get what you pay for!

For future reference, enter the following information:

Model No. _____ **Installation Date** _____

Serial No. (includes date code) _____

Water Hardness _____ **GPG** **Iron Content** _____ **PPM**

Model No. and Serial No. are on the shipping carton and on the conditioner/refiner's rating decal.

SPECIFICATIONS					
	ECR3700R20	ERR3700R20	ECR3700R30	ECR3702R30	ERR3702R30
Model Code	HR20	HR20+	HR30	2H30	2H30+
Rated Softening Capacity (Grains @ lb. Salt Dose)	5,500 @ 1.1 13,700 @ 4.3 18,400 @ 7.5	6,000 @ 1.3 14,900 @ 5.1 20,000 @ 8.9	8,100 @ 1.6 20,100 @ 6.3 27,100 @ 11.0	8,100 @ 1.6 20,100 @ 6.3 27,100 @ 11.0	8,100 @ 1.6 20,100 @ 6.3 27,100 @ 11.0
Rated Efficiency (gr./lb. of Salt at Min. Salt Dose)	5,030	4,610	5,030	5,030	5,030
Water Used During Regeneration	4.6 gal./1,000 grains	5.0 gal./1,000 grains	4.5 gal./1,000 grains	4.5 gal./1,000 grains	5.0 gal./1,000 grains
Service Flow Rate (gpm)	9.0	8.0	11.0	11.0	8.0
Pressure Drop at Service Flow Rate (psi)	10	7	8	8	8
Intermittent Flow Rate (gpm) @ 15 psi ▲	12.0	14.8	16.5	16.5	14.2
Intermittent Flow Rate (gpm) @ 30 psi ▲	19.4	23.6	25.8	25.8	21.4
Amount of High Capacity Resin (cu. ft.)	0.60	0.71	0.89	0.89	0.88
Water Supply Max. Hardness (gpg)	40	50	60	60	60
Water Supply Max. Clear Water Iron (ppm) ■	10	10	12	12	12
Min.-Max. Working Pressure (psi) ◆	20 - 125				
Min.-Max. Operating Temperature (°F)	40 - 120				
Min. Water Supply Flow Rate (gpm)	3				
Max. Flow Rate (gpm) to Drain during Recharge	2.4	3.0	3.0	3.0	3.0

SPECIFICATIONS					
	ECR3702R40	ECR3702R50S	ERR3702R50	ECR3702R70	ERRC3702R50
Model Code	2H40	2H50	2R50	2H70	2H50+
Rated Softening Capacity (Grains @ lb. Salt Dose)	10,900 @ 2.2 27,000 @ 8.5 36,300 @ 14.8	21,600 @ 4.5 39,500 @ 11.0 50,000 @ 17.4	21,000 @ 4.7 35,300 @ 9.7 49,900 @ 19.5	32,900 @ 6.2 57,600 @ 12.8 71,500 @ 25.6	21,600 @ 4.5 39,500 @ 11.0 50,000 @ 17.4
Rated Efficiency (gr./lb. of Salt at Min. Salt Dose)	5,030	4,800	4,440	5,310	4,800
Water Used During Regeneration	4.7 gal./1,000 grains	3.8 gal./1,000 grains	3.9 gal./1,000 grains	2.9 gal./1,000 grains	3.8 gal./1,000 grains
Service Flow Rate (gpm)	12.0	20.0	10.9	12.0	12.0
Pressure Drop at Service Flow Rate (psi)	13	13	8	11	10
Intermittent Flow Rate (gpm) @ 15 psi ▲	13.6	21.5	15.8	17.0	15.0
Intermittent Flow Rate (gpm) @ 30 psi ▲	21.6	32.2	24.0	22.0	21.0
Amount of High Capacity Resin (cu. ft.)	1.18	1.53	1.56	2.05	1.53
Water Supply Max. Hardness (gpg)	75	95	95	125	95
Water Supply Max. Clear Water Iron (ppm) ■	15	15	15	15	15
Min.-Max. Working Pressure (psi) ◆	20 - 125				
Min.-Max. Operating Temperature (°F)	40 - 120				
Min. Water Supply Flow Rate (gpm)	3				
Max. Flow Rate (gpm) to Drain during Recharge	3.0	4.0	4.0	4.0	4.0

▲ Intermittent flow rate does not represent the maximum service flow rate used for determining the unit's rated capacity and efficiency. Continuous operation at flow rates greater than the service flow rate may affect capacity and efficiency performance. The validity of these flow rates is verified by Water Quality Association (WQA).

■ Capacity to remove clear water iron is substantiated by independent laboratory test data. State of Wisconsin requires additional treatment if water supply contains greater than 5 ppm clear water iron.

◆ Canada working pressure limits: 1.4 - 7.0 kg/cm².

These units conform to NSF/ANSI 44 for the specific performance claims as verified and substantiated by test data.

These models are efficiency rated. The efficiency rating is valid only at the minimum salt dose and the service flow rate. The softeners have a demand initiated regeneration (D.I.R) feature that complies with specific performance specifications intended to minimize the amount of regenerant brine and water used in their operation.

These softeners have a rated softener efficiency of not less than 3,350 grains of total hardness exchange per pound of salt (based on sodium chloride) and shall not deliver more salt than their listed rating or be operated at a sustained maximum service flow rate greater than their listed rating. These softeners have been proven to deliver soft water for at least ten continuous minutes at the rated service flow rate. The rated salt efficiency is measured by laboratory tests described in NSF/ANSI Standard 44. These tests represent the maximum possible efficiency that the system can achieve. Operational efficiency is the actual efficiency after the system has been installed. It is typically less than the rated efficiency, due to individual application factors including water hardness, water usage, and other contaminants that reduce a softener's capacity.

While testing was performed under standard laboratory conditions, actual performance of the system may vary based on local water conditions.

PERFORMANCE CLAIMS		
Contaminant	Influent Challenge Level	Maximum Allowable Product Water Level
Barium	10 ±10% mg/L	2.0 mg/L
Radium 226/228	25 pCi/L	5 pCi/L

Test parameters include: pH = 7.5 ±0.5, flow rate = 7.5 gpm, and dynamic pressure = 35 ±5 psig.

Models ERR3700R20, ERR3702R30 and ERR3702R50 have been tested according to NSF/ANSI Standard 42 for the reduction of chlorine taste and odor. The concentration of the indicated substance in water entering the system was reduced to a concentration less than or equal to the permissible limit for water leaving the system, as specified in NSF/ANSI Standard 42.

PERFORMANCE CLAIMS		
Substance	Influent Challenge Level	Reduction Requirement
Chlorine	2.0 ±10% mg/L	50%

		Model ERR3700R20	Model ERR3702R30	Model ERR3702R50
Rated Capacity at Chlorine Concentration** of:	0.50 ppm	2,920,000 gal.*	3,650,000 gal.*	4,867,000 gal.*
	0.75 ppm	1,950,000 gal.*	2,440,000 gal.*	3,250,000 gal.*
	1.0 ppm	1,460,000 gal.*	1,820,000 gal.*	2,433,000 gal.*
	1.5 ppm	950,000 gal.*	1,910,000 gal.*	1,583,000 gal.*
	2.0 ppm	730,000 gal.	912,000 gal.*	1,217,000 gal.*

* From independent laboratory test data.

** Typical residential chlorine concentration is 0.5 to 1.0 ppm.

MODEL ERR3702R50 PERFORMANCE CLAIM		
Substance	Influent Challenge Level	Reduction Requirement
Chloramines	3 mg/L	>70% @ 10 gpm for 34,000 gal.***

*** From manufacturer's test data.

Cabinet Models

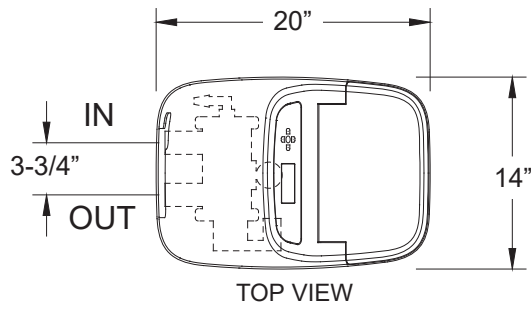

Model	Nominal Resin Tank Size
ECR3700R20	8" dia. x 35"
ECR3700R30	10" dia. x 35"
ERR3700R20	

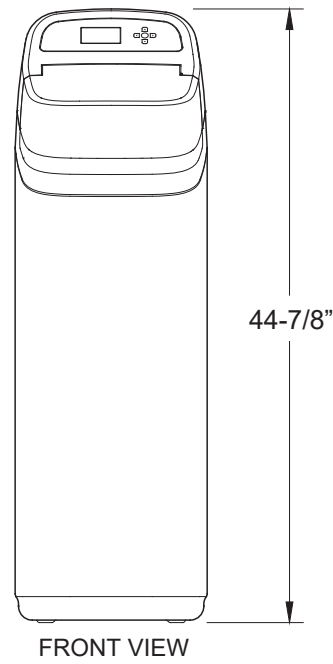
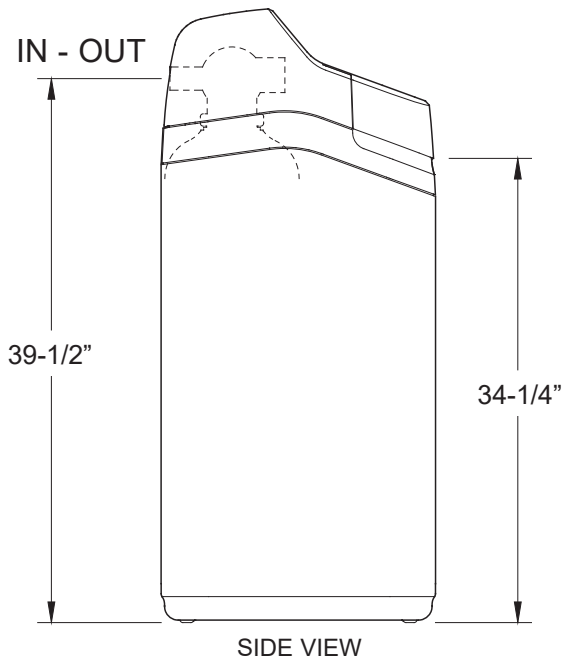

FIG. 1

Two-Tank Models

Model	Nominal Resin Tank Size	Dimension A	Dimension B
ECR3702R30	10" dia. x 35"	45"	39-1/8"
ERR3702R30	10" dia. x 47"	57"	51-1/8"
ECR3702R40			
ECR3702R50S	12" dia. x 54"	63"	57-1/8"
ERR3702R50			
ECR3702R70			
ERRC3702R50			

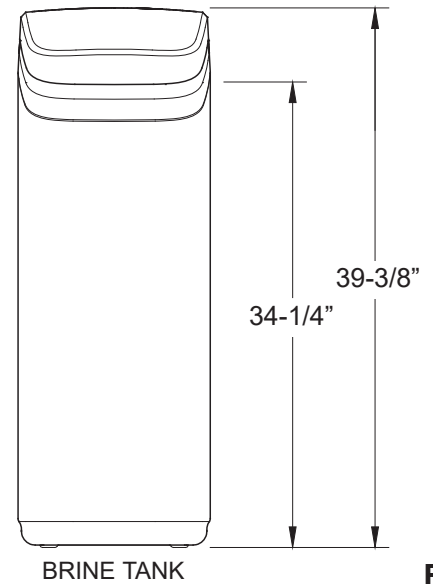
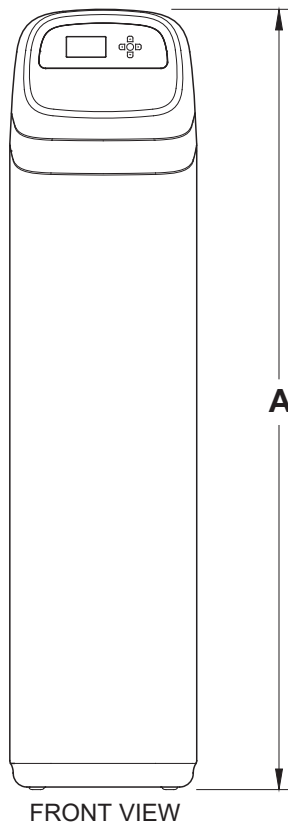
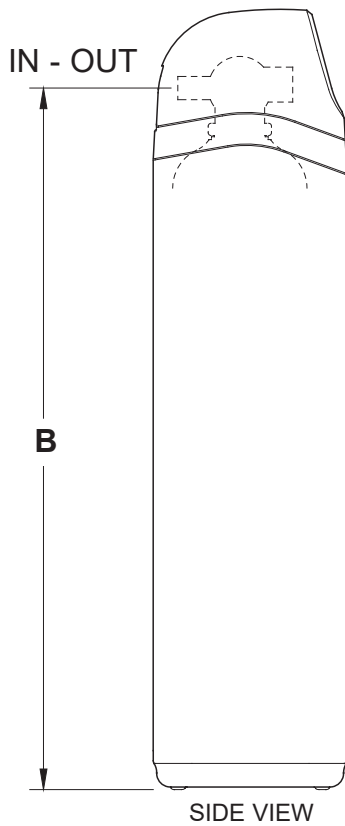
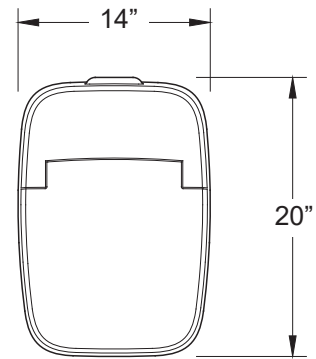
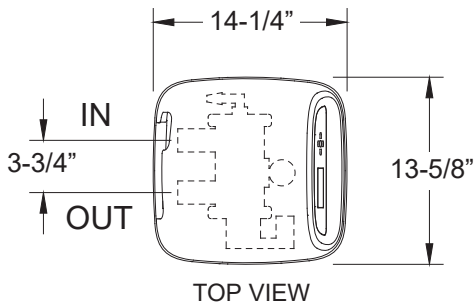

FIG. 2

TYPICAL INSTALLATION ILLUSTRATIONS

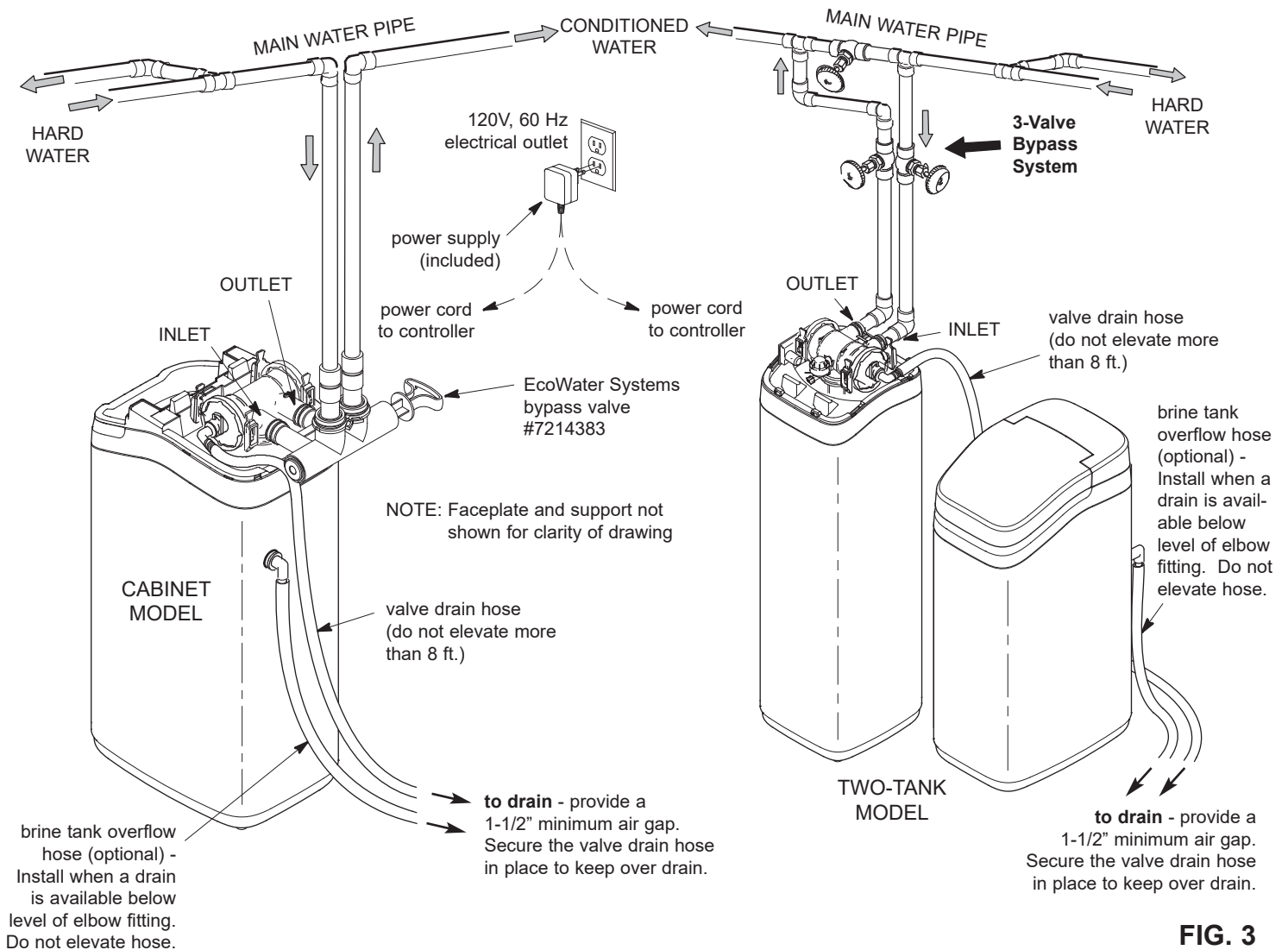

FIG. 3

INLET / OUTLET PLUMBING OPTIONS

- ALWAYS INSTALL either an EcoWater Systems bypass valve #7214383, or a 3-valve bypass system. Bypass valves allow you to turn off water to the conditioner/ refiner for repairs if needed, but still have water in house pipes.

OTHER REQUIREMENTS

- If installing in an outside location, you must take the steps necessary to assure the conditioner/refiner, installation plumbing, wiring, etc., are as well protected from the elements, contamination, vandalism, etc., as when installed indoors.
- A 120V, 60 Hz, grounded, continuously "live" electrical outlet is needed, in a dry location near the EcoWater Systems conditioner/refiner.
- A drain is needed for recharge discharge water. A floor drain is preferred, close to the EcoWater Systems conditioner/refiner. A laundry tub, stand-pipe, etc., are other options. Be sure to provide a 1-1/2" minimum air gap, to prevent possible sewer water backup.

1. UNPACKING

EcoWater Systems conditioner/refiner models R20, R30 and R40 are shipped from the factory in one carton. The carton also includes a bag of small parts needed to assemble and install the unit, plus this manual.

EcoWater Systems conditioner/refiner models R50 and R70 are shipped from the factory in two cartons. One contains the resin tank/controller assembly, a bag of small parts needed to assemble and install the unit, plus this manual. The other contains the assembled brine tank.

Thoroughly check the EcoWater Systems conditioner/refiner for possible shipping damage and parts loss. Also inspect and note any damage to the shipping carton. Notify the transportation company if damage is present. EcoWater Systems is not responsible for in-transit damages.

Remove and discard (RECYCLE) all packing materials. We suggest you keep the small parts in the bag until you are ready to use them.

2. BRINE TANK (on two-tank models)

Complete all steps below for R20, R30 and R40 models. For models shipped with an assembled brine tank (R50 and R70), unsnap the brine tank cover assembly from the rim (pull on the hand hold along the back) and do steps f through h.

- a. Snap the rim into place on the brine tank (See Fig. 4).
- b. Lower the brinewell, with the slots at the bottom, into

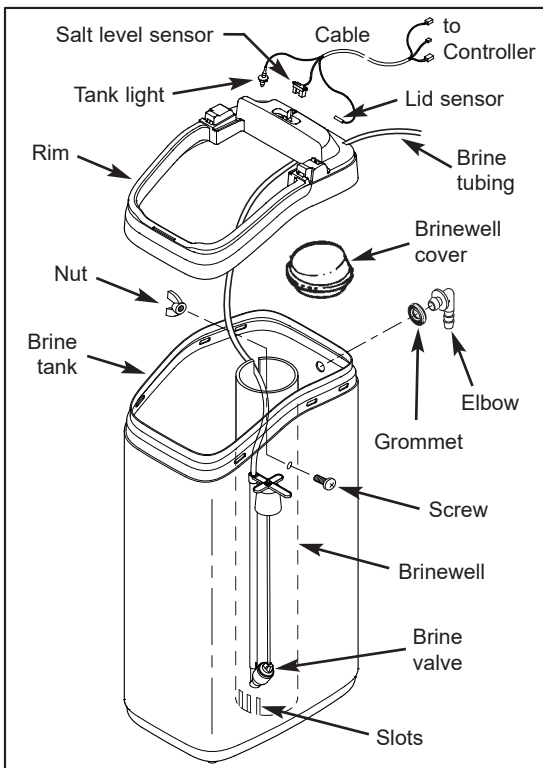

FIG. 4

the brine tank. Then use the screw and nut from the parts bag to fasten the brinewell in place along the side of the tank.

c. Lower the brine valve into the brinewell. Push the tubing into the brinewell top slot (Fig. 4) and route it out through the hole in the back of the rim.

d. Install the brinewell cover.

e. Take the rubber grommet and hose adaptor elbow from the parts bag. Push grommet into the hole in the back of the brine tank. Then insert the larger diameter end of the elbow through the grommet.

f. Locate the brine tank cable, one end of which is shipped plugged into the back of the electronic controller (PWA). At the loose end of this cable, identify the tank light, salt level sensor and cover sensor. Insert each of these three items into their corresponding slots in the rim, as shown in Figure 4.

g. Route the cable through the clip at the back of the rim.

h. Snap the brine tank cover assembly onto the rim, being careful not to pinch the wires of the brine tank cable.

3. INSTALL BYPASS VALVE and/or COPPER TUBES

a. If installing an **EcoWater Systems Bypass Valve**, put lubricated o-ring seals onto both bypass valve ports (See Figure 5B). Carefully slide the bypass valve into the conditioner/refiner valve and install the "C" clips.

b. Slide a lubricated o-ring seal onto each of the copper tubes. Carefully insert the copper tubes into the bypass valve (See Figure 5B), or into the conditioner/refiner valve (Figures 5 & 5A). Then install the "C" clips.

NOTE: For lubrication, use silicone grease approved for potable water supplies.

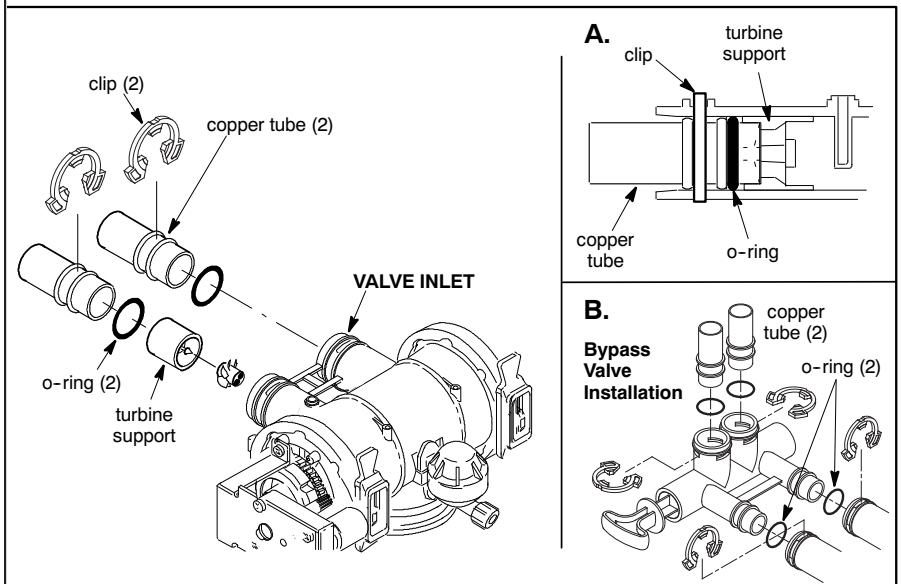

FIG. 5

4. TURN OFF WATER SUPPLY

- a. Close the main water supply valve near the well pump or water meter.
- b. Shut off the electric or fuel supply to the water heater.
- c. Open high and low faucets to drain all water from the house pipes.

5. INSTALLING THREE-VALVE BYPASS

If installing a 3-valve bypass system, plumb as needed using Figure 3 as a guide. When installing sweat copper, be sure to use lead-free solder and flux, required by federal and state codes. Use pipe joint compound on outside pipe threads.

6. ASSEMBLE INLET & OUTLET PLUMBING

Measure, cut, and loosely assemble pipe and fittings from the main water pipe (or from the bypass valves installed in Step 5), to the inlet and outlet copper tubes, installed in Step 3b.

Be sure **hard water** supply pipe goes to the valve **inlet side**. Trace the water flow direction to be sure.

7. CONNECT INLET & OUTLET PLUMBING

a. SOLDERED COPPER

- (1) Thoroughly clean and flux all joints.
- (2) Pull the plastic "C" clips and remove the inlet and outlet tubes from the valve. Remove o-rings from the

tubes. **DO NOT solder with tubes in the valve.** Soldering heat will damage the valve.

NOTE: If installing a ground as shown in Figure 6A, place ground clamps on copper tubes before soldering (See Step 7a).

- (3) Make all solder connections. Be sure to keep fittings fully together, and pipes square and straight.

b. THREADED PIPE

- (1) Apply pipe joint compound to all outside pipe threads.
- (2) Tighten all threaded joints.
- (3) If soldering to the inlet and outlet tubes, observe Step 7a above.

c. CPVC PLASTIC PIPE

- (1) Clean, prime and cement all joints, following the manufacturer's instructions supplied with the plastic pipe and fittings.
- (2) If soldering to the inlet and outlet tubes, observe Step 7a above.

8. COLD WATER PIPE GROUNDING

The house cold water pipe (metal only) is often used as a ground for the house electrical system. The 3-valve bypass type of installation, shown in Figure 3, will maintain ground continuity. If you use the plastic bypass, continuity is broken. To restore the ground, do the following.

- a. Install a #4 copper wire across the removed section of main water pipe, securely clamping at both ends (See Figure 6). Parts not included.

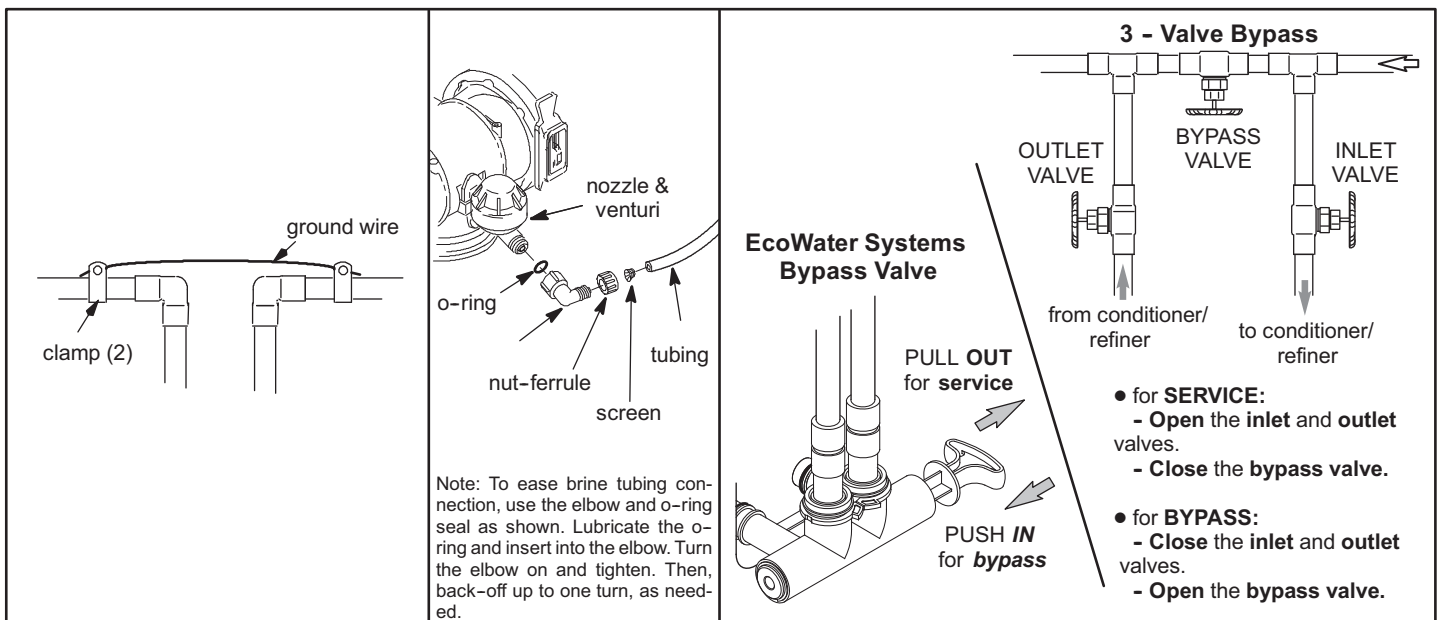

FIG. 6

FIG. 7

FIG. 8

9. INSTALL VALVE DRAIN HOSE

NOTE: See Fig. 3 on Page 8.

- a. Elevating the drain hose may cause back pressure that could reduce the brine draw during recharge. If raising the drain line overhead is required to get to the drain point, measure the inlet water pressure to the conditioner/refiner first. For inlet pressures between 20 and 50 psi, do not raise higher than 8 feet above the floor. For inlet pressure above 50 psi, the drain line may be raised to a maximum height of 14 feet.
- b. Connect a length of 1/2" I.D. hose (check codes) to the valve drain elbow, on the controller. Use a hose clamp to hold the hose in place. Route the hose out through the notch in the back of the top cover.
- c. Route the drain hose to a floor drain or other suitable drain point. Secure the end to prevent splashing or "whipping" during recharges. Be sure to provide a 1-1/2" minimum air gap, to prevent possible sewer water backup.

NOTE: If you are plumbing a rigid drain line, modify the top cover, as shown in Figure 9.

10. INSTALL BRINE TANK OVERFLOW HOSE (OPTIONAL)

- a. Connect a length of 1/2" I. D. hose to the brine tank overflow elbow and secure in place with a hose clamp.
- b. Route the hose to the floor drain, or other suitable drain point **no higher than the drain fitting** on the tank. If the tank overfills with water, the excess water flows to the drain point.

11. On Two-tank models, connect the brine tubing to the nozzle and venturi housing.

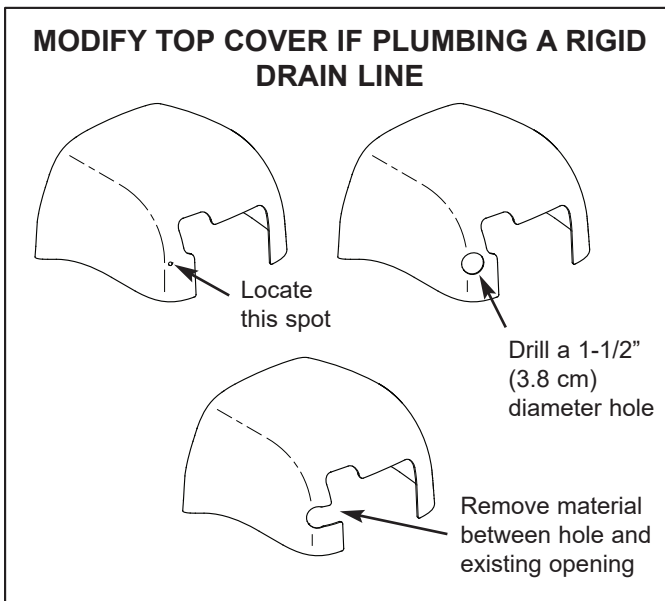

FIG. 9

12. PRESSURE TESTING FOR LEAKS, PROGRAMMING THE CONTROLLER & RINSING THE MEDIA

To prevent excessive air pressure in the EcoWater Systems conditioner/refiner and plumbing system, do the following steps EXACTLY in order:

- a. Fully open two or more **conditioned** cold water faucets nearby the EcoWater Systems conditioner/refiner.
- b. Place the bypass valve(s) in **bypass** position (See Figure 8).
- c. Fully open the main water supply valve. Watch until the flow from the opened faucets becomes steady, with no spurting or air bubbles.
- d. After about three minutes, open a hot water faucet for one minute, or until all air is expelled.
- e. Close all faucets and check your plumbing work for leaks.
- f. Make sure the conditioner/refiner's valve drain hose is hooked up and the open end directed to a floor drain, laundry tub or other suitable type of drain.
- g. Make sure the conditioner/refiner's bypass valve is in the **bypass** position.
- h. Plug in the power supply.
- i. **Program the electronic controller:** Follow the Setup Procedure on Pages 13-15 to program the electronic controller with basic operating information, such as time and water hardness. After completing the setup procedure, continue with "j. Start a recharge", below.
- j. **Start a recharge:** From the rolling status screens, press the SELECT (O) button to display the **Main menu**. Make sure **Recharge** is highlighted, then press SELECT (O). Press DOWN (▼) to scroll to **Recharge now**, then press SELECT (O) twice. You should hear the valve motor run as the conditioner/refiner begins recharging. Use the RIGHT (▶) button to advance the valve to the **backwash** position.
- k. Once the unit is in backwash, place bypass valve(s) into the **service** position, as follows:
 - (1) **SINGLE BYPASS VALVE:** **Slowly** move the valve stem toward **service** position, pausing several times to allow the unit to pressurize slowly.
 - (2) **3-VALVE BYPASS:** Fully close the **bypass** valve and open the **outlet** valve. **Slowly** open the **inlet** valve, pausing several times to allow the unit to pressurize slowly.
- l. Let the conditioner/refiner complete the backwash and fast rinse cycles (takes 10-12 minutes). When the recharge cycle ends, the conditioner/refiner valve returns to the service position.

13. ADD WATER AND SALT TO THE BRINE TANK

a. Using a pail or garden hose, add about 3 gallons of water into the brine tank. **DO NOT** pour into the brinewell.

b. Add salt to the brine tank. It is recommended to fill the brine tank no more than 1/2 full. Level the salt when finished adding. You can use most water conditioner salts, but it must be clean. Recommended nugget, pellet or coarse solar salts have less than 1% impurities.

NOTE: See page 31 for additional information on salt.

14. SANITIZING THE ECOWATER SYSTEMS CONDITIONER/REFINER

Care is taken at the factory to keep your EcoWater Systems conditioner/refiner clean and sanitary. However, during shipping, storage, installing and operating, bacteria could get into the unit. For this reason, sanitizing as follows is suggested* when installing.

a. Remove the brinewell cover and pour about 1-1/2 oz. (2 to 3 tablespoons) of common household bleach into the conditioner/refiner brinewell. Replace the brinewell cover.

*Recommended by the Water Quality Association. On some water supplies, the EcoWater Systems unit may need periodic disinfecting.

b. Make sure the bypass valve is in the **service** position.

c. Start a recharge: From the rolling status screens, press the SELECT (O) button to display the **Main menu**. Make sure **Recharge** is highlighted, then press SELECT (O). Press DOWN (▼) to scroll to **Recharge now**, then press SELECT (O) twice. You should hear the valve motor run as the conditioner/refiner begins recharging. This recharge draws the sanitizing bleach into and through the conditioner/refiner. Any air remaining in the unit is purged to the drain.

d. After the recharge has completed, fully open a cold water faucet, downstream from the conditioner/refiner, and allow 50 gallons of water to pass through the system. This should take at least 20 minutes. Close the faucet.

15. RESTART THE WATER HEATER

Turn on the electric or fuel supply to the water heater, and light the pilot, if applies.

NOTE: The water heater is filled with hard water and, as hot water is used, it refills with conditioned water. In a few days, the hot water will be fully conditioned. To have fully conditioned hot water immediately, wait until the recharge (Step 14) is complete, then drain the water heater until water runs cold.

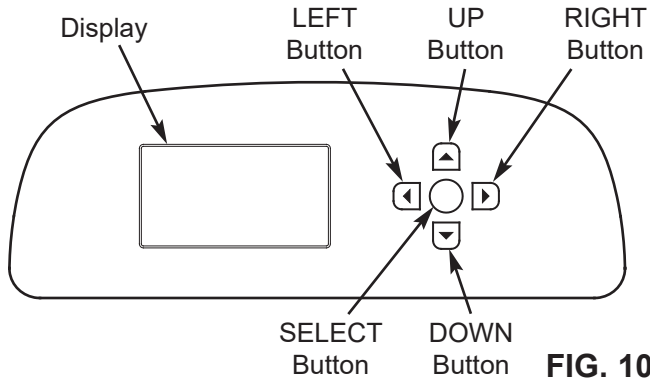

FIG. 10

SETUP PROCEDURE

When the EcoWater Systems conditioner/refiner is plugged in for the first time, a beep sounds and the display briefly shows a logo, followed by model information. Next, a series of “wizard” screens prompts you to enter basic operating information:

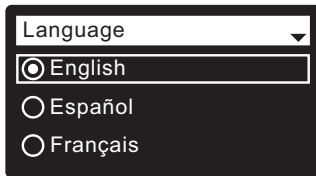

FIG. 11

- 1. LANGUAGE** If the desired language already has a dot next to it (See Figure 11), go to Step 2. Otherwise, press the conditioner/refiner’s DOWN (▼) or UP (▲) buttons to scroll to the desired language, then press the SELECT (○) button to choose it.
- Press the SELECT (○) button to advance to the next “wizard” screen.

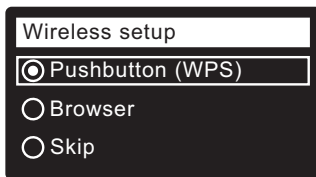

FIG. 12

NOTE: Wireless Setup can also be done after the rest of the Setup Procedure (Steps 16-28) has been completed. From the **Main menu**, go down to the **Advanced settings** menu and select **Wireless setup**.

- 3. WIRELESS SETUP** Choose how you will connect the softener to your home’s wireless network:
Browser: You can connect using the browser on your laptop, tablet or phone. Skip to Step 7.

OR

Pushbutton: If your wireless router has a **WPS** (Wi-Fi Protected Setup) or **Push to Connect** button, you can use this method to connect. Proceed to Step 4.

Pushbutton (WPS) Option

- Use the SELECT (○) button to choose **Pushbutton (WPS)**. The softener display will change to show “Push wireless router button”.

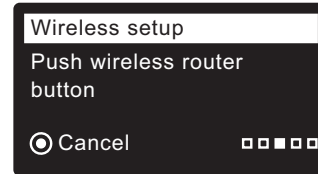

FIG. 13

- Press the WPS or Push to Connect button on your router and wait for a minute or two to see if the display changes again to “Connected” and gives you a key code. If not, you may need to cancel and use the browser option.

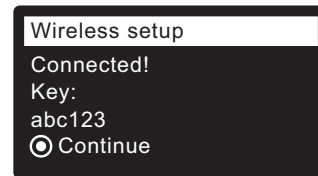

FIG. 14

- Once the key code is displayed, write it down. It will be used when you register your system on the EcoWater web site. Proceed to Step 16 on the next page.

NOTE: If the “Connected” message shows “-----” (dashes) instead of a key code, it may be that your router is not connected to the internet. Verify that the router’s internet connection works with your laptop or other device.

Browser Option

- Press the conditioner/refiner’s DOWN (▼) button to scroll to **Browser**.

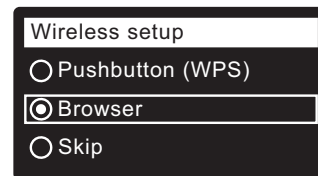

FIG. 15

- Press the SELECT (○) button twice. The softener display will change to show “See connection instructions”.

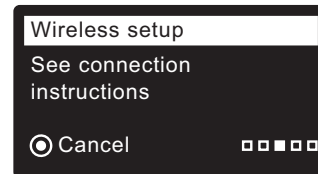

FIG. 16

continued on the next page

continued from the previous page

- On your laptop, tablet or phone, activate the view of wireless networks in range. For example, on a laptop, look for and click on the wireless icon along the lower right edge of the screen. On a phone, you should go into "Settings" and look for "Wi-Fi".



FIG. 17

- You should see a network named "H2O-" followed by 12 characters. Select this network to connect your device with it.

- Once your device indicates that it is connected to the H2O network, go to your internet browser (Chrome, Firefox, Internet Explorer, etc.) and type in this URL:

192.168.0.1

then click Go or press Enter.

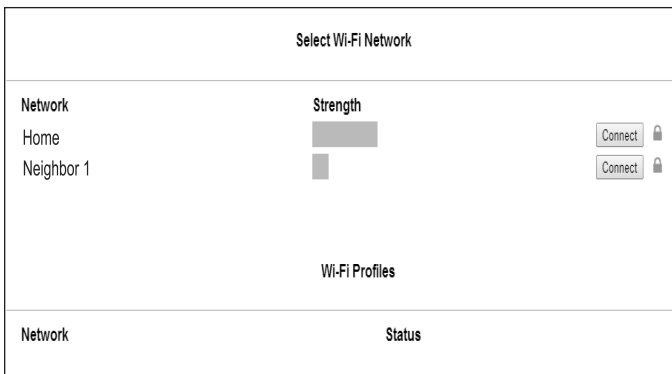

FIG. 18

- After a screen like the one shown above appears, select your in-home wireless network and enter the correct password.
- The softener display should change to "Connected" and give you a key code.

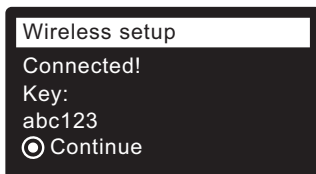

FIG. 19

- Once the key code is displayed (it may take a few seconds), write it down. It will be used when you register your system on the EcoWater web site.

NOTE: If the "Connected" message shows "-----" (dashes) instead of a key code, it may be that your router is not connected to the internet. Verify that the router's internet connection works with your laptop or other device.

- On your laptop, tablet or phone, go back to the view of networks in range, and make sure that your device is connected back to your local network.

Finish Setting up the Softener

- Once you have connected the Wi-Fi system and written down your key code, press the SELECT (O) button to advance to the next "wizard" screen.

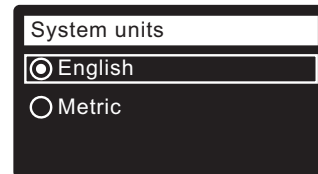

FIG. 20

- SYSTEM UNITS** If the desired system already has a dot next to it (See Figure 20), go to Step 18. Otherwise, press the DOWN (▼) or UP (▲) buttons to scroll to the desired system, then press the SELECT (O) button to choose it.

- Press the SELECT (O) button.

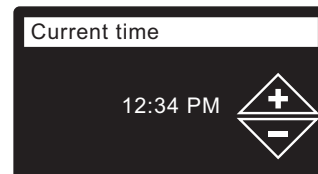

FIG. 21

- CURRENT TIME** Press the DOWN (▼) or UP (▲) buttons to set the current time (See Figure 21). Hold the button down to rapidly advance. Be sure that AM or PM is correct. If the system units were set to metric in Step 17, the clock will be in 24-hour format.

- Press the SELECT (O) button.

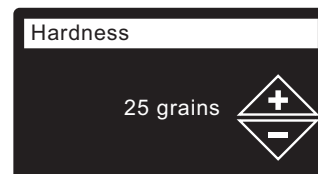

FIG. 22

- HARDNESS** Press the UP (▲) or DOWN (▼) buttons to set the value of your water's hardness (See Figure 22).

NOTE: Do not increase the hardness setting to compensate for iron in your water. The electronic control compensates automatically after you set the iron level in Step 23, below.

22. Press the SELECT (O) button.

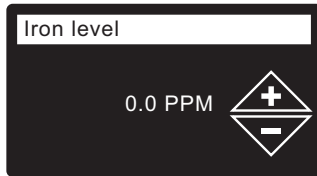

FIG. 23

23. **IRON LEVEL** Press the UP (▲) or DOWN (▼) buttons to set the value for iron in your water (See Figure 23).

24. Press the SELECT (O) button. The screen will show “Setup complete!” (See Figure 24).

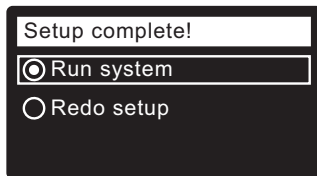

FIG. 24

25. If, at this point, you want to go back and make changes, press the DOWN (▼) button to scroll to **Redo setup**, then press the SELECT (O) button twice to repeat the “wizard” screens.

26. If no changes are desired, make sure **Run system** has a dot next to it (See Figure 24) and press the SELECT (O) button. The unit begins normal operation, described on Page 17.

HOW TO REGISTER A SYSTEM ON THE ECOWATER WEB SITE AS A DEALER

NOTE: A dealer registering softeners must log in as a dealer, not as a customer.

27. In your internet browser, type in this URL:

<http://wifi.ecowater.com>

28. If you are a dealer, and have an account, log in to your account and go to the next step. If you are a customer, go to Page 16 for instructions to create an account and register.

29. After you’ve logged in to your dealer account, click “Add New Customer System” and then enter the key code that you wrote down earlier. If you wait too long between writing down the key code and registering (an hour or less), the code may change. This is a security feature. Look up the new key code, as described in the following note.

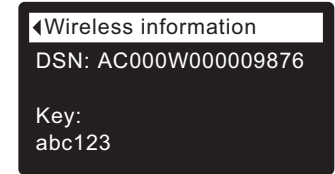
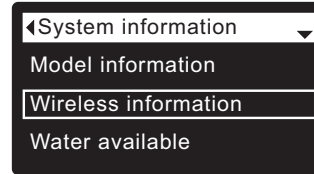

FIG. 25

NOTE: You can look up the current key code on your softener’s controller. From the **Main menu**, go down to the **System information** menu and select **Wireless information**.

30. After you’ve entered the key code in the **Add System** screen, click the “Connect” button to advance to the **Customer Information** screen.

31. Fill in the customer information (address, e-mail, etc.). When entering a password, either have the customer enter their own, or enter one for them and give it to them. If you intend to share the system, sharing needs to be done from the customer’s account (See “How to Share a System” on the following page). When finished filling in the customer information screen, click the “Save and Continue” button.

NOTE: When filling in address information, be sure to select the country before attempting to select a state or province.

32. Fill in the **System Settings** screen and click the “Save Settings” button.

33. Fill in the **Dealer Communication Preferences** screen and click the “Save and Continue” button.

34. The message “Customer System Setup Complete” should appear, along with the customer’s account screen. At this point you can make changes or add another system for this customer. When everything is correct, return to the dealer Home page by clicking the “Home” tab along the top of the page.

35. On the dealer Home page, the new system you set up should appear on the systems list.

NOTE: On the dealer Home page, the number of shared systems is displayed below the bar along the top of the screen. You can display only shared systems by clicking “shared with you”, and display all systems again by clicking the “Home” tab. See the following page for instructions on how to share a system.

HOW TO CREATE AN ACCOUNT AND REGISTER YOUR SYSTEM ON THE ECOWATER WEB SITE AS A CUSTOMER

NOTE: A dealer registering softeners must log in as a dealer, not as a customer.

1. In your internet browser, type in this URL:
http://wifi.ecowater.com
 2. If you are a new customer, click on “Create Account” to advance to the **Create Your Account** screen.
 3. Fill in the account information (e-mail, password, language, etc.). Agree to the Terms of Use, and then click the “Create Account” button to advance to the **Customer Information** screen.
 4. Fill in the customer information (name, address, etc.). When finished filling in the customer information screen, click the “Save and Continue” button.
- NOTE:** When filling in address information, be sure to select the country before attempting to select a state or province.
5. Follow the instructions on the **Verify e-mail** screen. You will shortly receive an e-mail confirming that you have created your account. Open this e-mail and click on the link it contains. Your browser will be directed to a **Verification Complete** screen.
 6. Now that you have created your account, you may log in. In the verification screen, click the “logging in” link (or go to **http://wifi.ecowater.com**).
 7. Log in with the e-mail and password that you entered when creating your account.
 8. After you’ve created and logged in to your account, the **Add System** screen will appear. Enter the key code that you wrote down earlier. If you wait too long between writing down the key code and registering (an hour or less), the code may change. This is a security feature. Look up the new key code, as described in the following note.

9. After you’ve entered the key code in the **Add System** screen, click the “Connect” button to advance to the **System Settings** screen.
10. Fill in the **System Settings** screen and click the “Save Settings” button.
11. Fill in the **Communication Preferences** screen and click the “Save and Continue” button.
12. The screen should change to show the Home page for your system, including the softener “dashboard”. Click the “Log Out” tab when you are done.

VISITING YOUR CUSTOMER ACCOUNT

Any time after your customer account has been created and system registered, you can visit your account to see your softener “dashboard”, change settings, etc. Direct your browser to **http://wifi.ecowater.com** and log in using the e-mail and password that were specified when setting up the account.

HOW TO SHARE A SYSTEM BETWEEN A DEALER AND CUSTOMER

NOTE: A system can only be shared from a customer’s account, not a dealer’s.

Systems can be “shared” between a dealer and customer. If a system is shared, the dealer has full access to the displays and settings for that system on the EcoWater Wi-Fi web site. If a system is not shared, the dealer only has access to the “Dealer Communication Preferences” screen for that system.

Once a customer account has been created by a dealer, a customer can grant a dealer access to their system. Access can only be granted to the dealer who sold that system.

With permission, a dealer (but only the one who sold the system) could also grant it for the customer. To do so, a dealer must log in as a customer rather than as a dealer, using the customer’s e-mail and password (which were entered when the customer account was created).

1. Go to **http://wifi.ecowater.com** and log in (customer’s e-mail and password, not dealer’s).
2. Click on the “Support” tab along the top of the customer Home page.
3. On the **Support** screen, click the “Grant Access” button. It should change to read “Revoke Access”.
4. The system is now shared. Click the “Log Out” tab when you are done.

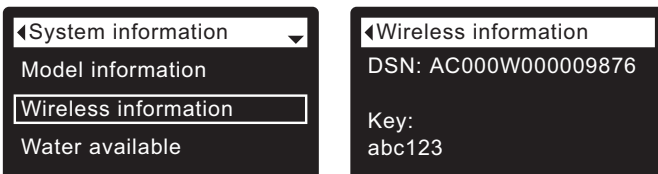

FIG. 26

NOTE: You can look up the current key code on your softener’s controller. From the **Main menu**, go down to the **System information** menu and select **Wireless information**.

NORMAL OPERATION

CONDITIONER/REFINER STATUS SCREENS

During normal operation, the EcoWater Systems conditioner/refiner's display shows up to five status screens. Page 23 explains how individual screens can be turned on or off. Each is shown for six seconds, in a rolling sequence (See Figure 27).

On the "Wireless status" screen, the check marks indicate the following:

- ✓ **WiFi** - The softener is connected to a Wi-Fi router.
- ✓ **Internet** - The softener is connected to a Wi-Fi router which is connected to the internet.

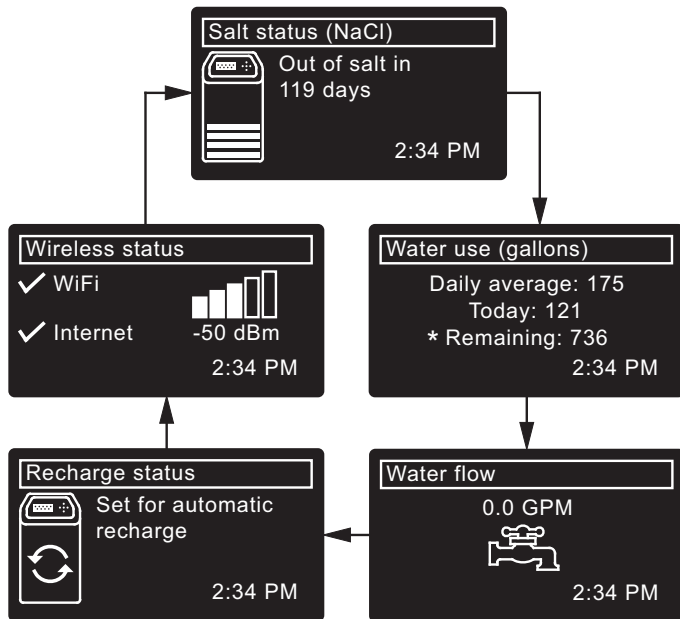

*Water remaining before the next recharge. **FIG. 27**

Pressing the conditioner/refiner's RIGHT (▶) button manually advances to the next screen in the sequence. Pressing the LEFT (◀) button manually returns to the previous status screen. If no buttons are pressed for 30 seconds, the automatic rolling sequence resumes.

OTHER MESSAGES, ALERTS & REMINDERS

The conditioner/refiner status screens described in the previous section will not be displayed in a rolling sequence when one of the following items is displayed:

- **Recharge status** (Displayed during recharges, showing valve position and time remaining)
- **Add salt or Out of salt** (See Page 31)
- **Current time** setting screen instead of status screens indicates time has been lost, perhaps after a long power loss. Set the time (See Page 21).
- **Service reminder** (See Page 29)
- **Error detected** (Contact your dealer for service)

FLASHING DISPLAY

The conditioner/refiner's display will flash on and off when one or more of the following conditions occurs:

- Salt needs to be added
- Time needs to be set (Time has been lost)
- Service is overdue (Service reminder)
- Error condition

The flashing will stop after any key is pressed. However, it will start again at Midnight if the underlying condition (e.g. low salt level) has not been addressed.

LONG DISPLAY SCREEN MESSAGES

Most messages in the conditioner/refiner's display screens are short enough to be shown as a single line. Longer messages will be truncated (See Figure 28 for an example) until you highlight them.

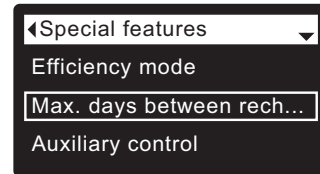

FIG. 28

One second after being highlighted, the viewing box expands (See Figure 29) to show the entire message. After three seconds the view resets (Figure 28).

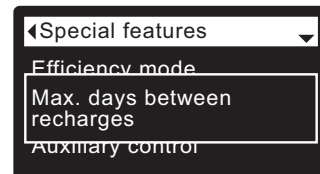

FIG. 29

MAIN MENU

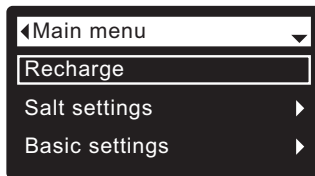

FIG. 30

During normal operation (status screens rolling), press the conditioner/refiner’s SELECT (O) button to display the Main menu (See Figure 30). This menu and its subsidiary screens are used to control these operations:

- **Recharge** (See Page 21)
- **Salt settings**
 - **Low salt alarm** (See Page 20)
 - **Salt type** (See Page 20)
- **Basic settings**
 - **Current time** (See Page 21)
 - **Hardness** (See Page 22)
 - **Iron level** (See Page 22)
 - **Recharge time** (See Page 22)
 - **Rolling screens** (See Page 23)
- **User preferences**
 - **Language** (See Page 23)
 - **Time format** (See Page 24)
 - **Volume units** (See Page 24)
 - **Hardness units** (See Page 24)
 - **Weight units** (See Page 24)
- **System information**
 - **Model information** (See Page 25)
 - **Wireless information** (See Page 25)
 - **Water available** (See Page 25)
 - **Daily avg. water used** (See Page 25)
 - **Water used today** (See Page 25)
 - **Total water used** (See Page 25)
 - **Current water flow** (See Page 25)
 - **Days powered up** (See Page 25)
 - **Last recharge** (See Page 25)
 - **Total recharges** (See Page 25)
- **Advanced settings**
 - **Cycle times**
 - **Backwash time** (See Page 26)
 - **2nd backwash (On/Off)** (See Page 26)
 - **2nd backwash time** (See Page 26)
 - **Fast rinse time** (See Page 26)
 - **Special features**
 - **Efficiency mode** (See Page 27)
 - **Max. days between recharges** (See Page 27)
 - **Auxiliary control** (See Page 28)
 - **Chemical feed volume**^① (See Page 28)
 - **Chemical feed timer**^① (See Page 28)
 - **97% feature** (See Page 27)
 - **Water to drain sensor** (See Page 29)
 - **Service reminder** (See Page 29)
- **Troubleshooting**
 - **Diagnostics** (See Page 30)
 - **Setup changes** (See Page 30)
 - **SLS calibration** (See Page 30)
- **Wireless setup** (See Pages 13-15)

① Only displayed if Auxiliary control is set to Chemical feed.

LOCKOUT FEATURE

A “lockout” feature is available to prevent user modification of parameters that affect conditioner/refiner performance. The unit is shipped from the factory with the lockout feature off. After programming is complete, the lockout feature can be turned on to prevent changes to the following:

- **Hardness**
- **Iron level**
- **Backwash time**
- **Second backwash (On/Off)**
- **Second backwash time**
- **Fast rinse time**
- **Efficiency mode**
- **Max days between recharges**
- **Auxiliary control**
- **Chemical feed volume**
- **Chemical feed timer**
- **97% feature**
- **Water to drain sensor**
- **Service reminder**
- **Setup changes**
- **SLS calibration point 0**
- **SLS calibration point 1**

To turn on the lockout feature:

1. From any of the rolling status screens, press the SELECT (O) button to display the **Main menu**.
2. Press the DOWN (▼) button to scroll through the menu options until **Advanced settings** is highlighted.
3. Press the SELECT (O) button to display the Advanced settings menu.
4. Press the DOWN (▼) button to scroll through the menu options until **Troubleshooting** is highlighted.
5. Press the SELECT (O) button to display the Troubleshooting menu.
6. Press the DOWN (▼) button to scroll through the menu options until **Setup changes** is highlighted.
7. Press the SELECT (O) button to display the Setup changes menu (See Figure 31).

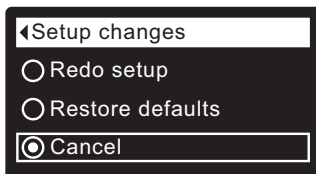

FIG. 31

8. Press the RIGHT (▶) button. A flashing padlock icon will appear, as shown in Figure 32.

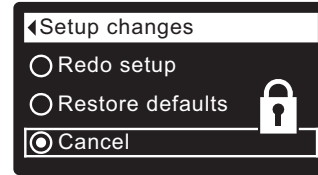

FIG. 32

9. Press the SELECT (O) button.
10. Press the LEFT (◀) button three times to return to the rolling status screens.

When the lockout feature is on, the flashing padlock icon will appear in any screen that would normally be used to change a parameter in the list to the left. For example, the **Hardness** screen will look like Figure 34, instead of Figure 33.



FIG. 33

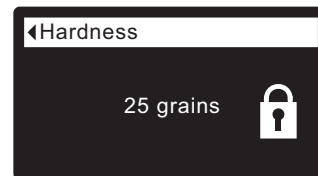

FIG. 34

Another indicator that the lockout feature is on is the **Model Information** screen. This screen appears on power-up, and can also be displayed from the System Information menu (See Page 25). If the lockout feature is on, there will be a non-flashing padlock icon in the upper right corner (See Figure 35).

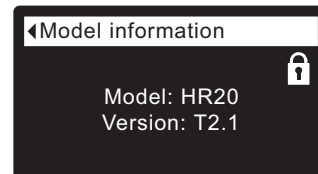

FIG. 35

To turn off the lockout feature:

- 1-7. Go to the **Setup changes** screen (Figure 32) by following Steps 1-7 at left.
8. Press the RIGHT (▶) button. The flashing padlock icon will disappear, as shown in Figure 31.
9. Press the SELECT (O) button.
10. Press the LEFT (◀) button three times to return to the rolling status screens.

LOW SALT ALARM

Use this feature to program when the electronic control will display a low salt alarm. The number of days can be customized, or the feature can be turned off. The default is 20 days.

1. From any of the rolling status screens, press the SELECT (O) button to display the **Main menu**.
2. Press the DOWN (▼) button to scroll through the menu options until **Salt settings** is highlighted (See Figure 36).

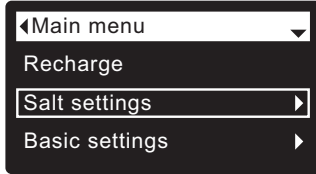

FIG. 36

3. Press the SELECT (O) button to display the Salt settings menu (See Figure 37).

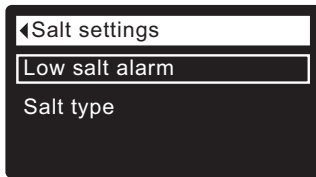

FIG. 37

4. Make sure **Low salt alarm** is highlighted.
5. Press the SELECT (O) button to display the Low salt alarm screen (See Figure 38).

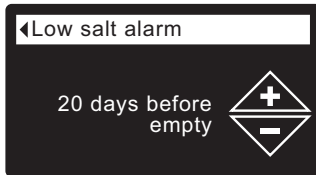

FIG. 38

6. Press the DOWN (▼) or UP (▲) buttons to change the number of days. Set the number of days to provide enough time to purchase salt and avoid running into hard water. Setting the number of days below 1 turns the alarm feature off.
7. Press the SELECT (O) button. The display will go back to the Salt settings menu (Figure 37).
8. Press the LEFT (◀) button twice to return to the rolling status screens.

SETTING SALT TYPE

Use this feature to program the electronic control with which type of salt is used. The default is NaCl. Selecting KCl increases fill time 25% and brine/slow rinse times 12%.

- 1-3. Go to the **Salt settings** menu by following Steps 1-3 in “Low Salt Alarm” at left.
4. Press the DOWN (▼) button to scroll through the menu options until **Salt type** is highlighted.
5. Press the SELECT (O) button to display the Salt type menu (See Figure 39).

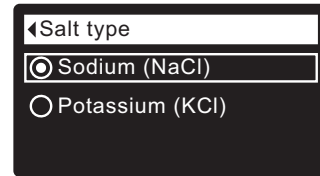

FIG. 39

6. If the desired salt type already has a black dot next to it (See Figure 39), go to Step 7. Otherwise, press the conditioner’s DOWN (▼) or UP (▲) buttons to scroll to the other salt type, then press SELECT (O) to choose it.
7. Press the SELECT (O) button. The display will go back to the Salt settings menu.
8. Press the LEFT (◀) button twice to return to the rolling status screens.

RECHARGING THE CONDITIONER/REFINER

This feature may be used to assure an adequate supply of conditioned water at times of unusually high water use. For example, if you have guests and the “Water available” screen (See Page 25) is at or below 50%, you could deplete conditioned water capacity before the next automatic recharge. Initiating a manual recharge will restore 100% conditioned water capacity after complete.

1. From any of the rolling status screens, press the SELECT (O) button to display the **Main menu**.

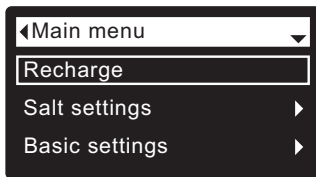

FIG. 40

2. Make sure **Recharge** is highlighted (See Figure 40).
3. Press the SELECT (O) button to display the Recharge menu (See Figure 41).

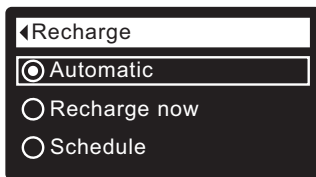

FIG. 41

4. If the desired option already has a dot next to it (See Figure 41), go to Step 5. Otherwise, press the DOWN (▼) or UP (▲) buttons to scroll to the desired option, then press SELECT (O) to choose it.

- **Automatic** cancels a manually scheduled recharge (if it has not already begun) and lets the electronic control determine when to recharge next.

- **Recharge now** begins a recharge immediately after the SELECT (O) button is pushed again in Step 5.

- **Schedule** sets a recharge to begin at the preset recharge time (set according to the instructions on Page 22).

5. Press the SELECT (O) button. If **Recharge now** is selected, the display immediately goes to the Recharge status screen (See Figure 42). If **Automatic** or **Schedule** are selected, the display goes back to the Main menu (Figure 40).

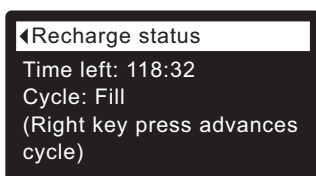

FIG. 42

6. Press the LEFT (◀) button (twice from the Recharge status screen) to return to the rolling status screens.

SETTING THE CURRENT TIME

When the conditioner/refiner’s electronic control is first powered up, a “wizard” screen prompts you to set the current time (See Pages 13-15). To change the time at a later date, such as after a long power loss:

1. From any of the rolling status screens, press the SELECT (O) button to display the **Main menu**.
2. Press the DOWN (▼) button to scroll through the menu options until **Basic settings** is highlighted (See Figure 43).

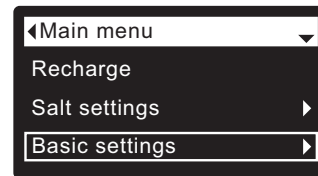

FIG. 43

3. Press the SELECT (O) button to display the Basic settings menu (See Figure 44).

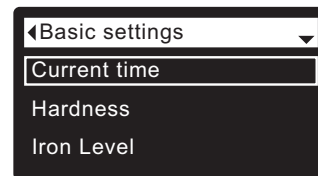

FIG. 44

4. Make sure **Current time** is highlighted.
5. Press the SELECT (O) button to display the Current time screen (See Figure 45).

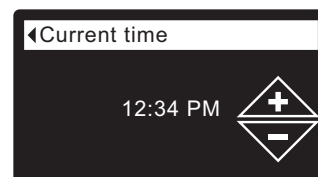

FIG. 45

6. Press the UP (▲) or DOWN (▼) buttons to change the time. Hold the button down to rapidly advance. Be sure that AM or PM is correct (unless conditioner/refiner is set for a 24-hour clock).
7. Press the SELECT (O) button. The display will go back to the Basic settings menu (Figure 44).
8. Press the LEFT (◀) button twice to return to the rolling status screens.

NOTE: On Wi-Fi connected systems, the current time will be updated and maintained automatically via Wi-Fi.

SETTING RECHARGE TIME

When the conditioner/refiner's electronic control is first powered up, the default time for starting an automatic recharge is 2:00 a.m. This is a good time in most households because water is not being used. To change this time:

1. From any of the rolling status screens, press the SELECT (O) button to display the **Main menu**.
2. Press the DOWN (▼) button to scroll through the menu options until **Basic settings** is highlighted (See Figure 46).

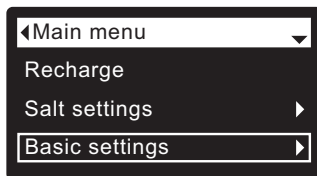

FIG. 46

3. Press the SELECT (O) button to display the Basic settings menu (See Figure 47).

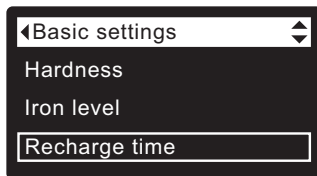

FIG. 47

4. Press the DOWN (▼) button to scroll through the menu options until **Recharge time** is highlighted.
5. Press the SELECT (O) button to display the Recharge time screen (See Figure 48).

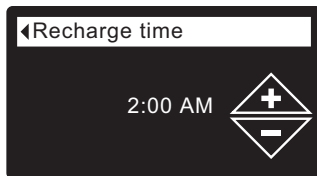

FIG. 48

6. Press the UP (▲) or DOWN (▼) buttons to change the recharge time in 1 hour increments. Hold the button down to rapidly advance. Be sure that AM or PM is correct (unless conditioner/refiner is set for a 24-hour clock).
7. Press the SELECT (O) button. The display will go back to the Basic settings menu (Figure 47).
8. Press the LEFT (◀) button twice to return to the rolling status screens.

SETTING HARDNESS

When the conditioner/refiner's electronic control is first powered up, a "wizard" screen prompts you to enter your water's hardness (See Pages 13-15). To change it:

- 1-3. Go to the **Basic settings** menu by following Steps 1-3 in "Setting Recharge Time" at left.
4. Press the DOWN (▼) button to scroll through the menu options until **Hardness** is highlighted.
5. Press the SELECT (O) button to display the Hardness screen (See Figure 49).

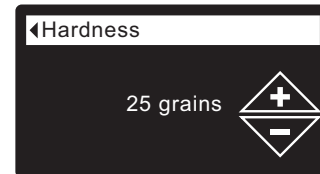

FIG. 49

6. Press the UP (▲) or DOWN (▼) buttons to set the value for your water's hardness. Hold the button down to rapidly advance.

NOTE: Do not increase the hardness setting to compensate for iron in your water. The electronic control compensates automatically after you set the iron level, below.

7. Press the SELECT (O) button. The display will go back to the Basic settings menu.
8. Press the LEFT (◀) button twice to return to the rolling status screens.

SETTING IRON LEVEL

When the conditioner/refiner's electronic control is first powered up, a "wizard" screen prompts you to enter your water's iron level (See Pages 13-15). The conversion is 3 grains per ppm of clear water iron. To change:

- 1-3. Go to the **Basic settings** menu by following Steps 1-3 in "Setting Recharge Time" at left.
4. Press the DOWN (▼) button to scroll through the menu options until **Iron level** is highlighted.
5. Press the SELECT (O) button to display the Iron level screen (See Figure 50).

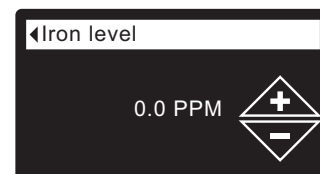

FIG. 50

6. Press the UP (▲) or DOWN (▼) buttons to set the value for iron in your water. Hold the button down to rapidly advance.
7. Press the SELECT (O) button. The display will go back to the Basic settings menu.
8. Press the LEFT (◀) button twice to return to the rolling status screens.

MODIFYING ROLLING SCREENS

During normal conditioner/refiner operation, up to five status screens are shown in sequence (See “Conditioner/Refiner Status Screens” on Page 17). When the conditioner/refiner’s electronic control is first powered up, the default is to show all four. You can turn on/off individual screens*:

1. From any of the rolling status screens, press the SELECT (O) button to display the **Main menu**.
2. Press the DOWN (▼) button to scroll through the menu options until **Basic settings** is highlighted (See Figure 51).

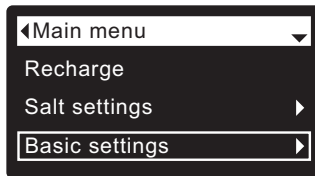

FIG. 51

3. Press the SELECT (O) button to display the Basic settings menu (See Figure 52).

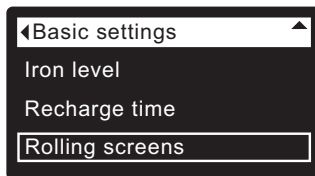

FIG. 52

4. Press the DOWN (▼) button to scroll through the menu options until **Rolling screens** is highlighted.
5. Press the SELECT (O) button to display the Rolling screens menu (See Figure 53).

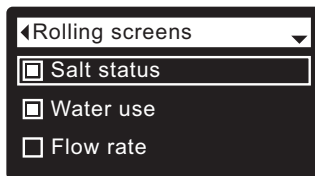

FIG. 53

6. Press the DOWN (▼) or UP (▲) buttons to scroll through the list. Items with a black square next to them will be displayed during normal operation.
7. To un-select a screen, make sure its name is highlighted in a box. Then press the SELECT (O) button. The black square will disappear. Pressing SELECT (O) again makes the black square reappear and re-selects the highlighted item. At least one screen must be selected/highlighted.
8. When selections are complete, exit this menu by pressing the LEFT (◀) button. The display will go back to the Basic settings menu (Figure 52).
9. Press the LEFT (◀) button twice to return to the rolling status screens.

*This does not include service reminders, errors, alerts or Recharge status screens.

SETTING THE LANGUAGE

When the conditioner/refiner’s electronic control is first powered up, a “wizard” screen prompts you to set the language (See Pages 13-15). To change the language:

1. From any of the rolling status screens, press the SELECT (O) button to display the **Main menu**.
2. Press the DOWN (▼) button to scroll through the menu options until **User preferences** is highlighted (See Figure 54).

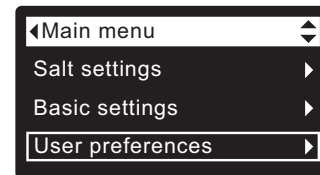

FIG. 54

3. Press the SELECT (O) button to display the User preferences menu (See Figure 55).

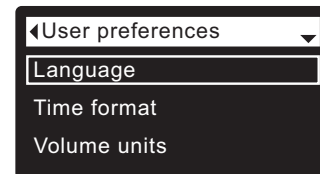

FIG. 55

4. Make sure **Language** is highlighted.
5. Press the SELECT (O) button to display the Language menu (See Figure 56).

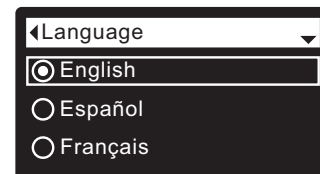

FIG. 56

6. If the desired language already has a dot next to it (See Figure 56), go to Step 7. Otherwise, press the DOWN (▼) or UP (▲) buttons to scroll to the desired language, then press SELECT (O) to choose it. The choices are: English, Spanish, French, Italian, German, Dutch, Polish, Russian, Hungarian, Turkish, Lithuanian, Greek, Romanian, Czech, Slovak, Bulgarian, Serbian or Croatian.
7. Press the SELECT (O) button. The display will go back to the User preferences menu (Figure 55).
8. Press the LEFT (◀) button twice to return to the rolling status screens.

TO SET THE CONDITIONER/REFINER TO ENGLISH IF ANOTHER LANGUAGE IS DISPLAYED:

From the rolling status screens, press SELECT (O). Press DOWN (▼) three times, then press SELECT (O) twice. Press UP (▲) to scroll to **English** at the top of the list, then press SELECT (O) twice. Press LEFT (◀) twice to exit all menus.

SETTING TIME FORMAT

Use this feature to select a 12-hour (AM/PM) or 24-hour clock.

1. From any of the rolling status screens, press the SELECT (O) button to display the **Main menu**.
2. Press the DOWN (▼) button to scroll through the menu options until **User preferences** is highlighted.
3. Press the SELECT (O) button to display the User preferences menu.
4. Press the DOWN (▼) button to scroll through the menu options until **Time format** is highlighted.
5. Press the SELECT (O) button to display the Time format menu (See Figure 57).

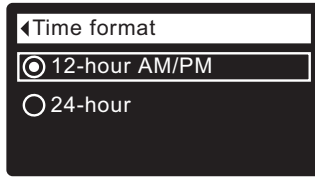

FIG. 57

6. If the desired time format already has a dot next to it (See Figure 57), go to Step 7. Otherwise, press the DOWN (▼) or UP (▲) buttons to scroll to the other time format, then press SELECT (O) to choose it.
7. Press the SELECT (O) button. The display will go back to the User preferences menu.
8. Press the LEFT (◀) button twice to return to the rolling status screens.

SETTING VOLUME UNITS

Use this feature to select gallons or liters as volume units.

- 1-3. Go to the **User preferences** menu by following Steps 1-3 in "Setting Time Format" above.
4. Press the DOWN (▼) button to scroll through the menu options until **Volume units** is highlighted.
5. Press the SELECT (O) button to display the Volume units menu (See Figure 58).

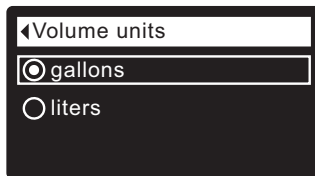

FIG. 58

6. If the desired volume unit already has a dot next to it (See Figure 58), go to Step 7. Otherwise, press the DOWN (▼) or UP (▲) buttons to scroll to the other volume unit, then press SELECT (O) to choose it.
7. Press the SELECT (O) button. The display will go back to the User preferences menu.
8. Press the LEFT (◀) button twice to return to the rolling status screens.

SETTING HARDNESS UNITS

Use this feature to select grains or parts per million (ppm) as hardness units.

1. From any of the rolling status screens, press the SELECT (O) button to display the **Main menu**.
2. Press the DOWN (▼) button to scroll through the menu options until **User preferences** is highlighted.
3. Press the SELECT (O) button to display the User preferences menu.
4. Press the DOWN (▼) button to scroll through the menu options until **Hardness units** is highlighted.
5. Press the SELECT (O) button to display the Hardness units menu (See Figure 59).

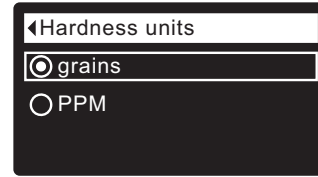

FIG. 59

6. If the desired hardness unit already has a dot next to it (See Figure 59), go to Step 7. Otherwise, press the DOWN (▼) or UP (▲) buttons to scroll to the other hardness unit, then press SELECT (O) to choose it.
7. Press the SELECT (O) button. The display will go back to the User preferences menu.
8. Press the LEFT (◀) button twice to return to the rolling status screens.

SETTING WEIGHT UNITS

Use this feature to select pounds or kilograms as weight units.

- 1-3. Go to the **User preferences** menu by following Steps 1-3 in "Setting Hardness Units" above.
4. Press the DOWN (▼) button to scroll through the menu options until **Weight units** is highlighted.
5. Press the SELECT (O) button to display the Weight units menu (See Figure 60).

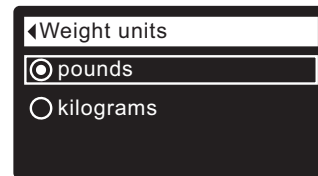

FIG. 60

6. If the desired weight unit already has a dot next to it (See Figure 60), go to Step 7. Otherwise, press the DOWN (▼) or UP (▲) buttons to scroll to the other weight unit, then press SELECT (O) to choose it.
7. Press the SELECT (O) button. The display will go back to the User preferences menu.
8. Press the LEFT (◀) button twice to return to the rolling status screens.

SYSTEM INFORMATION

Use these features to look up the following information about the conditioner/refiner and its operations:

- **Model information** (model number and software version)
- **Wireless information**
- **Water available** (conditioned water ready for use)
- **Daily average water used**
- **Water used today**
- **Total water used** (explained in Step 6, below)
- **Current water flow**
- **Days powered up**
- **Last recharge**
- **Total recharges**

To display one of these screens:

1. From any of the rolling status screens, press the SELECT (O) button to display the **Main menu**.
2. Press the DOWN (▼) button to scroll through the menu options until **System information** is highlighted (See Figure 61).

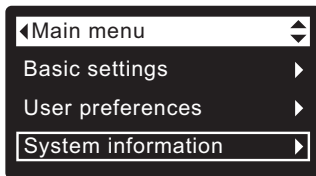

FIG. 61

3. Press the SELECT (O) button to display the System information menu (See Figure 62).

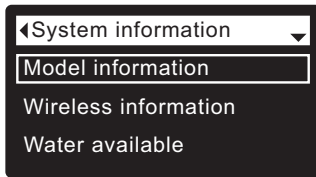

FIG. 62

4. Press the DOWN (▼) button to scroll through the menu options until the desired option is highlighted (See list at the top of this column).
5. Press the SELECT (O) button to display the desired information screen (See Figures 63-72).
6. The **Total water used** screen (See Figure 68) shows the volume of water used since it was last reset (it works like the trip odometer in a car). To reset the value to 0, press the RIGHT (▶) button while this screen is displayed.
7. When finished viewing an information screen, press the SELECT (O) button. The display will go back to the System information menu (Figure 62). It will also exit automatically if no buttons are pressed for four minutes.
8. Press the LEFT (◀) button twice to return to the rolling status screens.

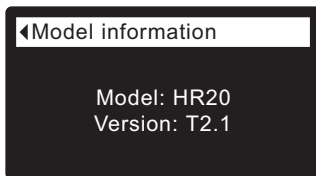

FIG. 63

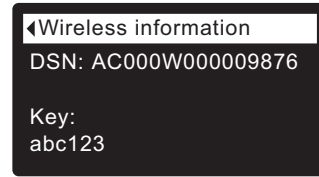

FIG. 64

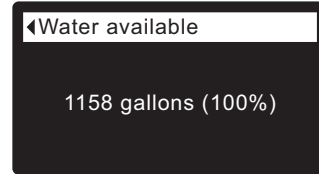

FIG. 65

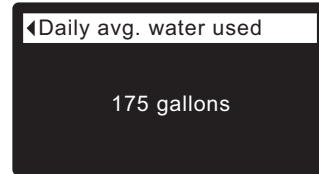

FIG. 66

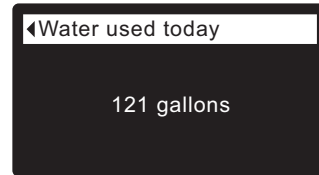

FIG. 67

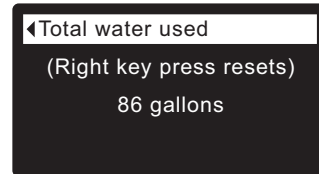

FIG. 68

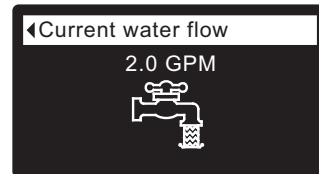

FIG. 69

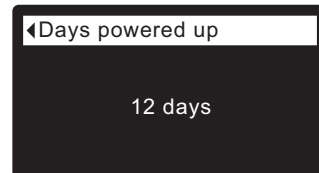

FIG. 70

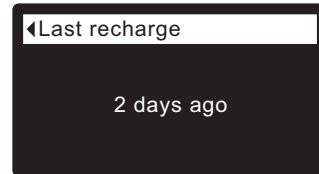

FIG. 71

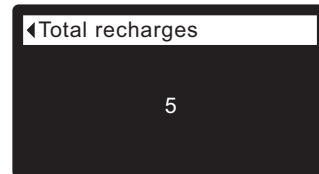

FIG. 72

CYCLE TIMES

Use these features to change the following conditioner/refiner operations:

- **Backwash time**
- **Second backwash (On/Off)**
- **Second backwash time**
- **Fast rinse time**

To display these screens:

1. From any of the rolling status screens, press the SELECT (O) button to display the **Main menu**.
2. Press the DOWN (▼) button to scroll through the menu options until **Advanced settings** is highlighted (See Figure 73).

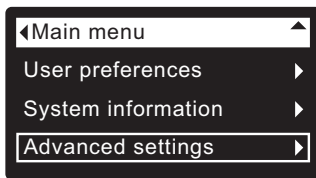

FIG. 73

3. Press the SELECT (O) button to display the Advanced settings menu (See Figure 74).

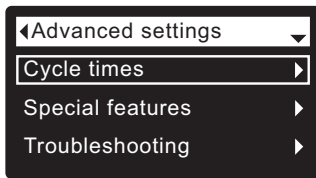

FIG. 74

4. Make sure **Cycle times** is highlighted.
5. Press the SELECT (O) button to display the Cycle times menu (See Figure 75).

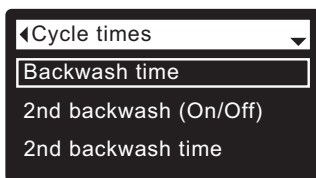

FIG. 75

6. Press the DOWN (▼) button to scroll through the menu options until the desired option is highlighted (See list at the top of this column).
7. Press the SELECT (O) button to display the desired cycle time screen (See Figures 76-79).
8. **See the right column on this page for specific instructions on each cycle time screen.**
9. Press the SELECT (O) button. The display will go back to the Cycle times menu (Figure 75).
10. Press the LEFT (◀) button three times to return to the rolling status screens.

- 8a. **Backwash time:** Press the UP (▲) or DOWN (▼) buttons to change the backwash time. Hold the button down to rapidly advance. The backwash time can be set from 1 to 30 minutes* (See Figure 76).



FIG. 76

- 8b. **Second backwash (On/Off):** If the desired option already has a dot next to it (See Figure 77), go to Step 9. Otherwise, press the DOWN (▼) or UP (▲) buttons to scroll to the other option, then press SELECT (O) to choose it. Setting this feature On adds a second backwash and rinse at the beginning of the recharge cycle. Default is Off. Set this feature On if your water supply contains a lot of sediment or iron.

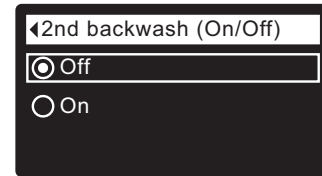

FIG. 77

- 8c. **Second backwash time:** Press the UP (▲) or DOWN (▼) buttons to change the second backwash time. Hold the button down to rapidly advance. The time can be set from 0 to 30 minutes (See Figure 78).

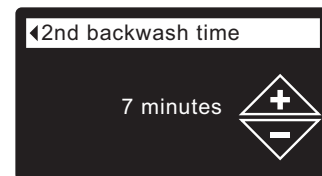

FIG. 78

- 8d. **Fast rinse time:** Press the UP (▲) or DOWN (▼) buttons to change the fast rinse time. Hold the button down to rapidly advance. The fast rinse time can be set from 1 to 30 minutes* (See Figure 79).



FIG. 79

*Reducing the backwash and fast rinse times below a conditioner/refiner model's default settings can result in salty water after recharges.

SPECIAL FEATURES

Use these features to change the following operations:

- **Efficiency mode**
- **Maximum days between recharges**
- **Auxiliary control** (described on Page 28)
- **Chemical feed volume*** (described on Page 28)
- **Chemical feed timer*** (described on Page 28)
- **97% feature**
- **Water to drain sensor** (described on Page 29)
- **Service reminder** (described on Page 29)

To display one these screens:

1. From any of the rolling status screens, press the SELECT (O) button to display the **Main menu**.
2. Press the DOWN (▼) button to scroll through the menu options until **Advanced settings** is highlighted (See Figure 80).

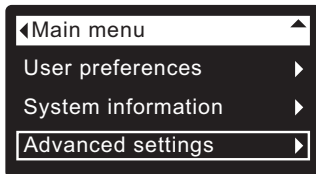

FIG. 80

3. Press the SELECT (O) button to display the Advanced settings menu (See Figure 81).

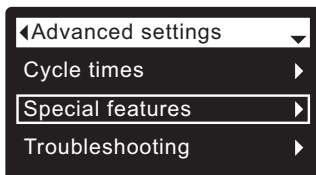

FIG. 81

4. Press the DOWN (▼) button to scroll through the menu options until **Special features** is highlighted.
5. Press the SELECT (O) button to display the Special features menu (See Figure 82).

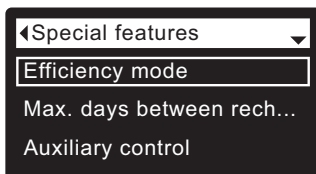

FIG. 82

6. Press the DOWN (▼) button to scroll through the menu options until the desired option is highlighted (See list at the top of this column).
7. Press the SELECT (O) button to display the desired special feature screen (See Figures 83-85).
8. **See the right column on this page for specific instructions on each cycle time screen.**
9. Press the SELECT (O) button. The display will go back to the Special features menu (Figure 82).
10. Press the LEFT (◀) button three times to return to the rolling status screens.

*Only displayed if Auxiliary control is set to Chemical feed.

8a. Efficiency mode: If the desired efficiency mode already has a dot next to it (See Figure 83), go to Step 9. Otherwise, press the DOWN (▼) or UP (▲) buttons to scroll to the desired efficiency mode, then press SELECT (O) to choose it.

- **Salt efficient** limits available salt doses to maintain 4000 grains/lb. of salt efficiency. Units may recharge more frequently.

- **Auto adjusting** is the default. It automatically adjusts salt doses to target a 3-4 day interval between recharges. Recommended.

- **High capacity** is for applications where very low “bleed” (less than 1.5 ppm) of hardness can be tolerated. Such applications include water for boilers. This setting will consume higher quantities of salt.

NOTE: California regulations require the efficiency mode be set to **Salt efficient** for units installed in the state of California.

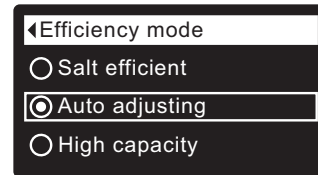

FIG. 83

8b. Maximum days between recharges: Press the UP (▲) or DOWN (▼) buttons to change the number of days (See Figure 84). The feature can be set from 1 to 15 days. Setting the number of days below 1 turns the feature off and defaults to automatic control of recharging.

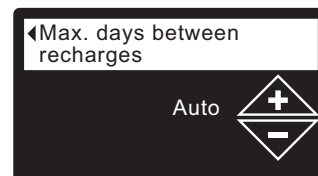

FIG. 84

8c. 97% feature: If the desired option already has a dot next to it (See Figure 85), go to Step 9. Otherwise, press the DOWN (▼) or UP (▲) buttons to scroll to the other option, then press SELECT (O) to choose it. If this feature is On, the conditioner/refiner will automatically recharge when 97% of capacity is used, at any time of day. Default is Off.



FIG. 85

AUXILIARY CONTROL

The electronic control has an auxiliary output which can control external devices in a water treatment system. The signal is 24V DC, current draw 500 mA maximum. The Auxiliary Output terminals are located on the electronic control board (See Schematic on Page 37).

For more details on the use of auxiliary controlled equipment in water treatment systems, consult the EcoWater Systems "Problem Water Guide."

To select an auxiliary control mode:

1. From any of the rolling status screens, press the SELECT (O) button to display the **Main menu**.
2. Press the DOWN (▼) button to scroll through the menu options until **Advanced settings** is highlighted.
3. Press the SELECT (O) button to display the Advanced settings menu.
4. Press the DOWN (▼) button to scroll through the menu options until **Special features** is highlighted.
5. Press the SELECT (O) button to display the Special features menu (See Figure 86).

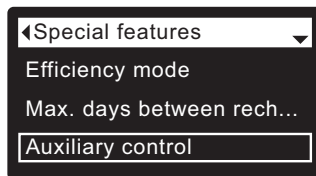

FIG. 86

6. Press the DOWN (▼) button to scroll through the menu options until **Auxiliary control** is highlighted.
7. Press the SELECT (O) button to display the Auxiliary control menu (See Figure 87).
8. If the desired option already has a dot next to it (See Figure 87), go to Step 9. Otherwise, press the DOWN (▼) or UP (▲) buttons to scroll to the desired option, then press SELECT (O) to choose it.
 - **Off** is the default. The 24V DC output is always off.
 - **On**: The 24V DC output is always on.
 - **Chlorine** can be used to drive a chlorine generator, which produces chlorine, as brine water passes through it, to sanitize the resin during recharges.
 - **Bypass**: Turns 24V DC on during the entire regeneration cycle (when the conditioner's valve is in bypass and hard water is going to the house).
 - **Chemical feed**: Can be used to run a chemical feed pump. If chosen, the chemical feed volume and timer must be set, as detailed at right)
 - **Water use**: Turns 24V DC on when the conditioner's turbine indicates water flow. Could drive an air pump for iron or sulfur oxidation.
 - **Fast Rinse**: Turns 24V DC on during the fast rinse portion of the regeneration cycle.
9. Press the SELECT (O) button. The display will go back to the Special features menu (Figure 86).
10. Press the LEFT (◀) button three times to return to the rolling status screens.

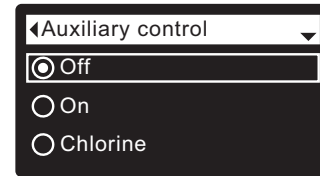

FIG. 87

CHEMICAL FEED

If the auxiliary control mode has been set to **Chemical feed**, as described in the previous section, two additional lines (**Chemical feed volume** and **Chemical feed timer**) will appear on the Special features menu.

To set these values:

1. From any of the rolling status screens, press the SELECT (O) button to display the **Main menu**.
2. Press the DOWN (▼) button to scroll through the menu options until **Advanced settings** is highlighted.
3. Press the SELECT (O) button to display the Advanced settings menu.
4. Press the DOWN (▼) button to scroll through the menu options until **Special features** is highlighted.
5. Press the SELECT (O) button to display the Special features menu (See Figure 86).
6. Press the DOWN (▼) button to scroll through the menu options until **Chemical feed volume** or **Chemical feed timer** is highlighted.
7. Press the SELECT (O) button to display the Chemical feed volume or Chemical feed timer menu (See Figures 88 & 89).

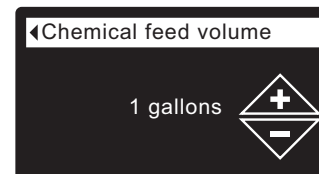

FIG. 88

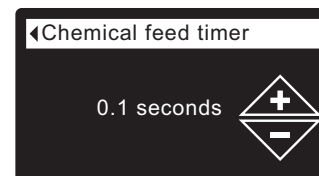

FIG. 89

8. Press the UP (▲) or DOWN (▼) buttons to change the value. Hold the button down to rapidly advance.
 - **Chemical feed volume** is the amount of water which will pass through the conditioner/refiner between each activation of the chemical feed equipment.
 - **Chemical feed timer** is how long the output to the chemical feed equipment is energized each time it is activated.
9. Press the SELECT (O) button. The display will go back to the Special features menu (Figure 86).
10. Press the LEFT (◀) button three times to return to the rolling status screens.

WATER TO DRAIN SENSOR

When this feature is On (the default setting), a sensor in the conditioner/refiner’s valve drain elbow fitting allows the electronic controller to detect whether water is continuously flowing to the drain after a recharge cycle has completed. This could indicate a possible internal valve leak. If detected, an alert will be sent via Wi-Fi, and a display screen will ask whether there is actually water flowing to the drain. Answering No will reset the water-to-drain sensor.

To turn this feature on or off:

1. From any of the rolling status screens, press the SELECT (O) button to display the **Main menu**.
2. Press the DOWN (▼) button to scroll through the menu options until **Advanced settings** is highlighted.
3. Press the SELECT (O) button to display the Advanced settings menu.
4. Press the DOWN (▼) button to scroll through the menu options until **Special features** is highlighted.
5. Press the SELECT (O) button to display the Special features menu (See Figure 90).

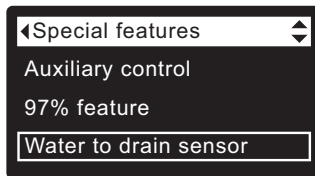

FIG. 90

6. Press the DOWN (▼) button to scroll through the menu options until **Water to drain sensor** is highlighted.
7. Press the SELECT (O) button to display the Water to drain sensor screen (See Figure 91).

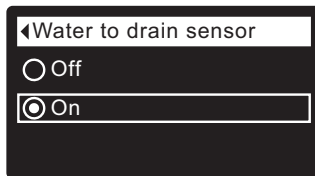

FIG. 91

8. If the desired option already has a dot next to it, go to Step 9. Otherwise, press the DOWN (▼) or UP (▲) buttons to scroll to the other option, then press SELECT (O) to choose it.
9. Press the SELECT (O) button. The display will go back to the Special features menu (Figure 90).
10. Press the LEFT (◀) button three times to return to the rolling status screens.

SERVICE REMINDER (set / reset)

Use this feature to program the number of months (up to 24) before a “Service overdue” message will appear instead of the rolling status screens (See Figure 92).

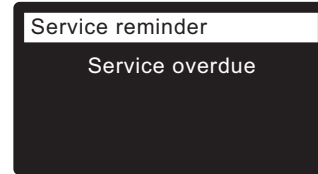

FIG. 92

This will be a reminder to call your dealer for service. Once programmed, this feature displays the number of months and days left until the service reminder.

Once the “Service overdue” message has appeared, dealers performing service clear it by setting the number of months until the next service reminder. Set or reset the service reminder as follows:

1. From any of the rolling status screens, press the SELECT (O) button to display the **Main menu**.
2. Press the DOWN (▼) button to scroll through the menu options until **Advanced settings** is highlighted.
3. Press the SELECT (O) button to display the Advanced settings menu.
4. Press the DOWN (▼) button to scroll through the menu options until **Special features** is highlighted.
5. Press the SELECT (O) button to display the Special features menu (See Figure 93).

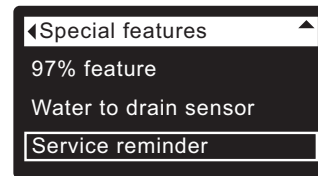

FIG. 93

6. Press the DOWN (▼) button to scroll through the menu options until **Service reminder** is highlighted.
7. Press the SELECT (O) button to display the Service reminder screen (See Figure 94).

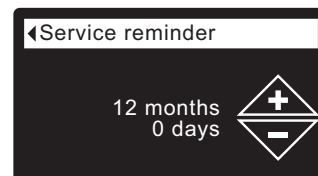

FIG. 94

8. Press the UP (▲) or DOWN (▼) buttons to set the number of months until the service reminder appears. Repeatedly pressing the DOWN (▼) button until the display reads “Off” turns this feature off and zeros the number of months and days.
9. Press the SELECT (O) button. The display will go back to the Special features menu (Figure 93).
10. Press the LEFT (◀) button three times to return to the rolling status screens.

DIAGNOSTICS

This feature allows a service technician to check the operating state of individual components in the conditioner/refiner (e.g. valve position) to troubleshoot problems. **If an error code is displayed in place of the rolling status screens, call your dealer for service.**

To view the Diagnostics screen:

1. If an error code is displayed, skip Steps 2-7 and go directly to Step 8.
2. To display the Diagnostics screen from any of the rolling status screens (when an error code is not displayed), press the SELECT (O) button to display the **Main menu**.
3. Press the DOWN (▼) button to scroll through the menu options until **Advanced settings** is highlighted.
4. Press the SELECT (O) button to display the Advanced settings menu.
5. Press the DOWN (▼) button to scroll through the menu options until **Troubleshooting** is highlighted.
6. Press the SELECT (O) button to display the Troubleshooting menu (See Figure 95).

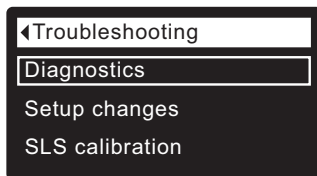

FIG. 95

7. Make sure **Diagnostics** is highlighted.
8. Press the SELECT (O) button to display the Diagnostics screen (See Figure 96).

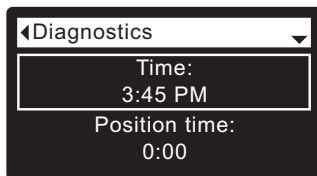

FIG. 96

9. Press the DOWN (▼) or UP (▲) buttons to scroll through the list. The following items are displayed:
 - **Time** (current)
 - **Position time** (counts down the time remaining in the current valve position)
 - **Current position** (of the valve: service, fill, brine, backwash, fast rinse or moving)
 - **Requested position** (of the valve)
 - **Motor state** (on or off)
 - **Valve position switch** (open or closed)
 - **Turbine count** (if changing, indicates water flow)
 - **Salt level sensor** (distance reading of sensor)
 - **Drain TDS** (total dissolved solids in ppm)
 - **Drain temperature** (°C)
 - **Tank light switch** (open or closed)
 - **RF module** (detected or not)
 - **Error code** (call for service if a number is displayed)
10. When finished viewing the Diagnostics screen, press the SELECT (O) button. The display will go back to the Troubleshooting menu.

11. Press the LEFT (◀) button three times to return to the rolling status screens (or error code screen if an error condition exists).

SETUP CHANGES

This feature allows a service technician to repeat the setup procedure (See Pages 13-15) or restore the conditioner/refiner's default operating values.

1. From any of the rolling status screens, press the SELECT (O) button to display the **Main menu**.
2. Press the DOWN (▼) button to scroll through the menu options until **Advanced settings** is highlighted.
3. Press the SELECT (O) button to display the Advanced settings menu.
4. Press the DOWN (▼) button to scroll through the menu options until **Troubleshooting** is highlighted.
5. Press the SELECT (O) button to display the Troubleshooting menu (See Figure 95).
6. Press the DOWN (▼) button to scroll through the menu options until **Setup changes** is highlighted.
7. Press the SELECT (O) button to display the Setup changes menu (See Figure 97).

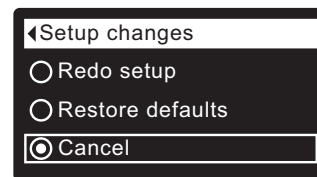

FIG. 97

8. If the desired option already has a dot next to it (See Figure 97), go to Step 9. Otherwise, press the DOWN (▼) or UP (▲) buttons to scroll to the desired option, then press SELECT (O) to choose it.
 - **Redo setup** allows you to select a different model code (intended to be used for upgrades or retrofits of existing conditioner/refiners). Model codes are listed on Page 4.
 - **Restore defaults** will reset all customizable settings to their default values and take you through the "wizard" screen setup procedure (See Pages 13-15).
 - **Cancel** will return to the Troubleshooting menu (Figure 95).
9. Press the SELECT (O) button.

SLS CALIBRATION

This feature is used by a service technician replacing a salt level sensor. A replacement salt level sensor is shipped from the factory with numerical values for two calibration points, and these values must be entered into the controller. Instructions for this procedure are supplied with the replacement salt level sensor.

NOTE: Do not change the numerical values of the SLS calibration points unless installing a replacement salt level sensor.

ADDING SALT

If the conditioner/refiner uses all the salt before more is added, hard water will result. EcoWater 3700/3702 series models have automatic salt level sensing. Your Wi-Fi account can also be used to monitor salt. The conditioner/refiner salt status screen has an optional display of the estimated number of days until salt is depleted (“Out of salt in X days”). The conditioner/refiner can also be programmed to display a Low Salt Alarm a certain number of days before salt is estimated to run out (See Page 20).

Be sure that the brinewell cover is on when adding salt.

NOTE: In humid areas it is best to keep the salt level less than half full and add salt more often.

RECOMMENDED SALT: Cube, pellet, coarse solar, etc., water conditioner salt is recommended. This type of salt is high purity evaporated crystals, sometimes formed and pressed into briquets. It has less than 1% insoluble (not dissolvable in water) impurities. Clean, high grade rock salts are acceptable, but may require frequent brine tank cleaning to remove the “sludge” residue (insolubles) collecting at the bottom of the tank.

POTASSIUM CHLORIDE: If you choose potassium chloride (KCl) salt as a regenerant:

- 1) Make sure “Salt type” on the electronic control is set to “KCl”, as shown on Page 20.
- 2) Place only one bag of potassium chloride (KCl) into your conditioner/refiner at a time. The salt storage tank should never contain more than 60 pounds of KCl.

SALT NOT RECOMMENDED: Rock salt high in impurities, block, granulated, table, ice melting, or ice cream making salts, etc., are not recommended.

SALT WITH IRON REMOVING ADDITIVE: Some salts have an additive to help a water conditioner/refiner handle iron in the water supply. Although this may help keep the resin bed clean, it may also release corrosive fumes that will weaken and shorten the life of some EcoWater Systems conditioner/refiner electronic parts. Iron Out salt is safe to use on two-tank models.

BREAKING A SALT BRIDGE

Sometimes a hard crust or salt “bridge” forms in the brine tank. This is usually caused by high humidity or the wrong kind of salt. When the salt bridges, an empty space forms between the water and the salt. Then salt will not dissolve in the water to make brine. Without brine, the resin bed is not recharged and hard water will result.

If the storage tank is full of salt, it is difficult to tell whether there is a salt bridge. A bridge may be underneath loose salt. The following is the best way to check for a salt bridge:

Salt should be loose all the way to the bottom of the tank. Hold a broom handle, or like tool, up to the conditioner/refiner, as shown in Figure 98. Make a pencil mark on the handle 1” - 2” below the top of the rim. Then, carefully push it straight down into the salt. If a hard object is felt before the pencil mark is even with the top, it is most likely a salt bridge. Carefully push into the bridge in several places to break it. **Do not try to break the salt bridge by pounding on the outside of the salt tank. You may damage the tank.**

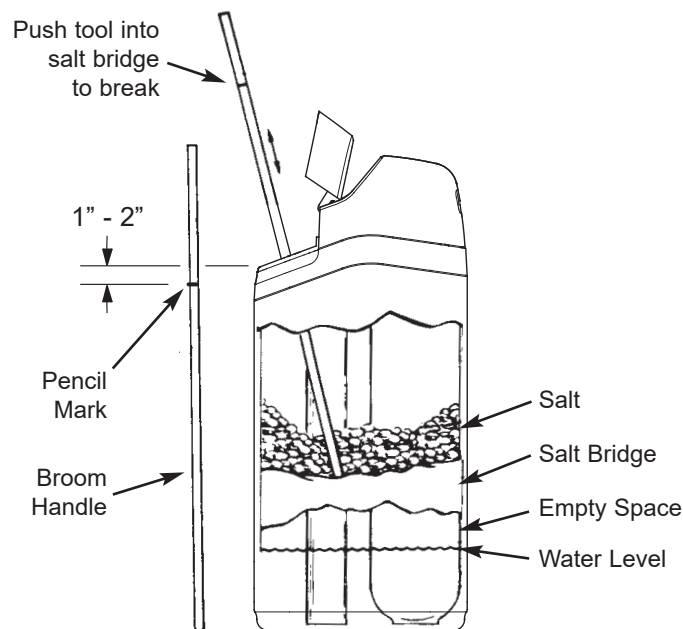

FIG. 98

CLEANING THE NOZZLE & VENTURI

A clean nozzle & venturi (See Figure 99) is necessary for the EcoWater Systems conditioner/refiner to work properly. This small unit creates the suction to move brine from the brine tank into the resin tank. If it should become plugged with dirt, silt, sand, etc., the EcoWater Systems conditioner/refiner will not work and hard water will result.

To get access to the nozzle & venturi, remove the conditioner/refiner's top cover. Put the bypass valve(s) into the bypass position. Be sure the conditioner/refiner is in the service cycle (no water pressure at the nozzle & venturi). Then, holding the nozzle & venturi housing with one hand, turn the cap to remove it. Do not lose the o-ring seal. Lift out the screen support and screen. Then, remove the nozzle & venturi. Wash the parts in warm, soapy water and rinse in fresh water. If needed, use a small brush to remove iron or dirt. Be careful not to scratch, misshape, etc., surfaces of the nozzle & venturi. Also, check and clean the gasket and flow plug(s) if dirty.

Carefully replace all parts in the correct order. Lubricate the o-ring seal with silicone grease and put in place. Install and tighten the cap, by hand only. Do not overtighten, which could break the cap or housing. Put the bypass valve(s) into service (conditioned water) position.

RESIN BED CLEANING

If the water supply contains clear water iron, regular resin bed cleaning is needed to keep the bed from coating with iron. Use resin bed cleaner, available from EcoWater Systems, following directions on the container. Clean the resin every six months, or more often if iron appears in the conditioned water supply.

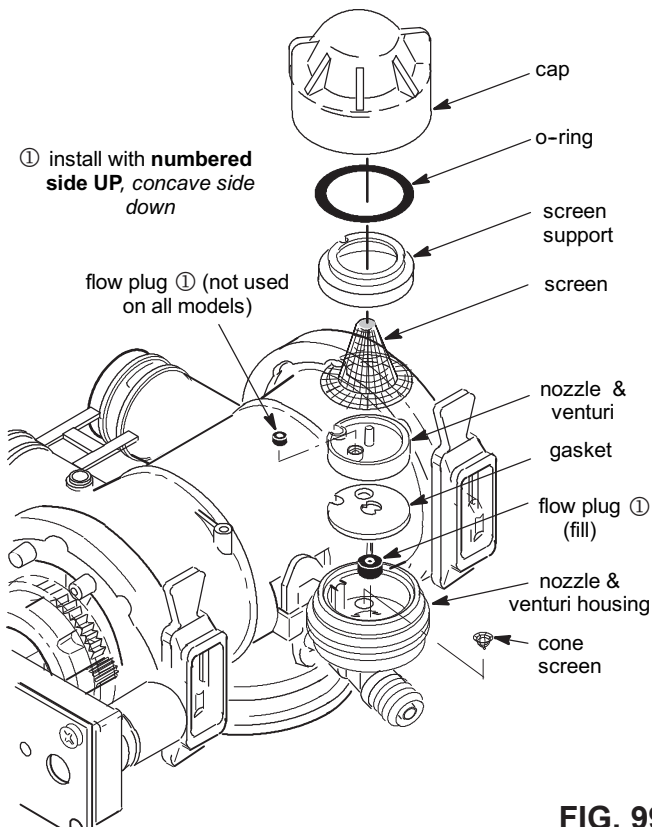

FIG. 99

RELIEVING WATER PRESSURE WITH THE BYPASS VALVE(S)

CAUTION: Always relieve water pressure in the EcoWater Systems conditioner/refiner, as described below, before removing parts from the valve or resin tank.

DE-PRESSURIZE

1. Put bypass valve(s) into **Bypass** position.
2. Place conditioner/refiner valve in **Fill** position by performing Steps 1 & 7 of Manual Advance Recharge procedure on Page 36.

PRESSURIZE

1. Put bypass valve(s) into **Service** position.
2. Return conditioner/refiner valve to **Service** position by performing Steps 10-16 of Manual Advance Recharge procedure on Page 36.

ALTERNATE METHODS:

3-VALVE BYPASS (See Figure 100)

DE-PRESSURIZE

1. Close the INLET valve.
2. Open HOT and COLD conditioned water house faucets.
3. Close the OUTLET valve and open the BYPASS valve.
4. Close all house faucets.

PRESSURIZE

1. Open HOT and COLD house faucets.
2. Close the BYPASS valve and open the OUTLET valve.
3. **Slowly**, open the INLET valve.
4. Close all house faucets.

ECOWATER SYSTEMS BYPASS VALVE (See Figure 101)

(See Figure 101)

DE-PRESSURIZE

1. Close the house main water supply valve.
2. Open HOT and COLD conditioned water house faucets.
3. Push the bypass valve handle to **Bypass** position.
4. Optional: For hard water bypass to house faucets, reopen the main water supply valve.

PRESSURIZE

1. Open main water supply valve if it is closed.
2. Open HOT and COLD house faucets.
3. Pull the bypass valve handle to **Service** position.
4. Close all house faucets.

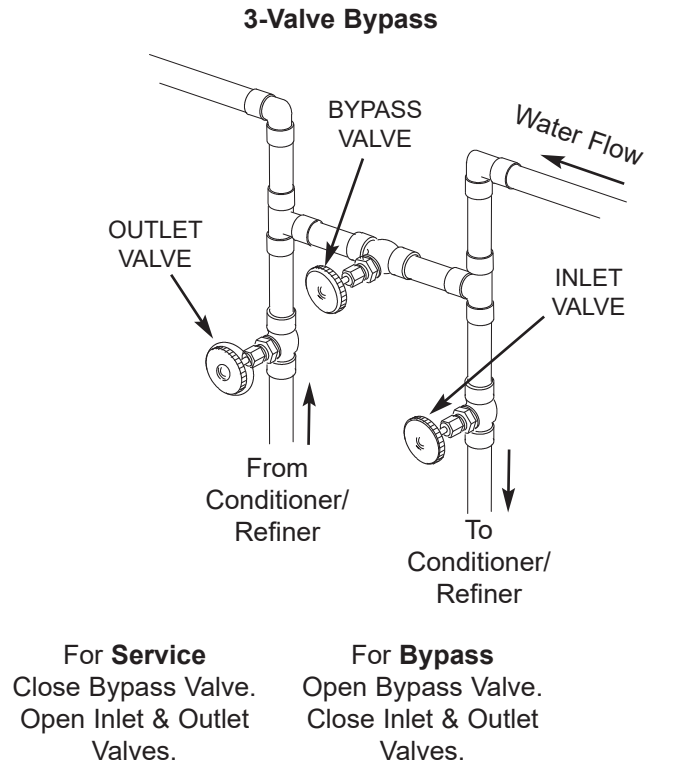

FIG. 100

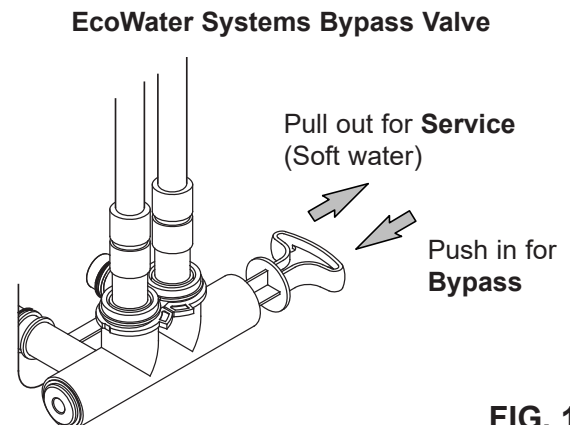



FIG. 101

TROUBLESHOOTING GUIDE

PROBLEM	CAUSE	CORRECTION
Cannot set some conditioner/refiner parameters and display shows a padlock icon: 	Lockout feature is on.	Turn off the lockout feature (See Page 19).
No soft water	No salt in the storage tank.	Add salt (See Page 31) and then initiate a "Recharge now," as shown on Page 21.
	Salt is "bridged."	Break salt bridge (See Page 31) and then initiate a "Recharge now," as shown on Page 21.
	If display is blank, power supply may be unplugged at wall outlet, power cable leads may be disconnected from the electronic control board, fuse may be blown, circuit breaker may be popped, or power supply may be plugged into a switched outlet which is "off."	Check for power loss due to any of these and correct. When power is restored, if the display shows the "Current Time" setting screen (Figure 45 on Page 21), it means time was lost during the outage. Set the current time. Other settings such as hardness are retained in memory during a power loss.
	Bypass valve(s) in bypass position.	Referring to Figure 8 on Page 10, place bypass valve(s) in service position.
	Dirty, plugged or damaged nozzle & venturi.	Take apart, clean and inspect the nozzle & venturi assembly, as shown on Page 32.
	Valve drain hose plugged or restricted.	Drain hose must not have any kinks, sharp bends, or be raised too high above the conditioner/refiner (See Page 10).
Water hard sometimes	Bypassed hard water being used during recharge, due to current time or recharge time settings being incorrect.	Check the current time displayed. If not correct, refer to "Set Current Time" on Page 21. Check the recharge time, as described on Page 22.
	Hardness number setting is too low.	Referring to "Setting Hardness" on Page 22, check the current hardness setting and increase if needed.
	Hot water being used when conditioner/refiner is recharging.	Avoid using hot water during recharges, because water heater refills with hard water.
	Increase in actual hardness of water supply.	Have unconditioned water sample tested. Referring to Page 22, check the current hardness setting and increase if needed.
	Turbine is not turning freely.	Check turbine, as described on Page 35.
Motor stalled or clicking	Motor malfunction or internal valve fault causing high torque on motor.	Contact your dealer for service.
Error code E1, E3 or E4 displayed.	Fault in wiring harness, connections to position switch, switch, valve or motor.	Contact your dealer for service.
Error code E5 displayed.	Electronic control malfunction.	Contact your dealer for service.

TROUBLESHOOTING - INITIAL CHECKS

Always make these initial checks first:

1. Is display blank? Check power source.
2. Is Error code displayed? If so, go to "Automatic Electronic Diagnostics" on the next page.
3. Is correct time displayed? If not, recharges occur at the wrong time. Set current time (See Page 21).
4. Is there salt in the brine tank? If not, refill.
5. Is salt "bridged" (See Page 31)?
6. Are plumbing bypass valve(s) in service position (See Figure 8 on Page 10)?
7. Are inlet and outlet pipes connected to the EcoWater conditioner/refiner inlet and outlet respectively?

8. Is valve drain hose free of kinks and sharp bends, and not elevated over 8 feet above the floor.
9. Is the brine tube connected (See Fig. 7 on Page 10)?
10. Check the hardness setting (See "Setting Hardness on Page 22). Be sure it is correct for the household's water supply. Perform a hardness test on a raw water sample to compare with the setting.
11. Perform a hardness test on a conditioned water sample to determine whether a problem exists.

If no problem is found after making the initial checks, proceed to "Troubleshooting - Manual Diagnostics" and "Manual Advance Recharge Check" on the next two pages.

AUTOMATIC ELECTRONIC DIAGNOSTICS

This conditioner/refiner has a self-diagnostic function for the electrical system (except for input power and/or water meter). The controller monitors electronic components and circuits for correct operation. If a malfunction occurs, an **Error code** is displayed (See Figure 102).

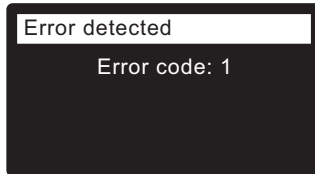

FIG. 102

The troubleshooting chart on the previous page shows the error codes that could appear, and the possible malfunctions for these codes.

When an error code appears in the display, pressing SELECT (O) will display the **Diagnostics** screen (See Page 30), so a service technician can further isolate the problem.

REMOVING ERROR CODE

1. Unplug power supply from electrical outlet.
2. Correct problem.
3. Plug power supply back in.
4. Wait for eight minutes while controller operates valve through an entire cycle. The error code will return if the problem was not corrected.

TROUBLESHOOTING - MANUAL DIAGNOSTICS

1. Display the **Diagnostics** screen, following the procedure on Page 30.
2. Press the DOWN (▼) or UP (▲) buttons to scroll through the list. The following items are displayed:
 - **Time** (current)
 - **Position time** (counts down the time remaining in the current valve position)
 - **Current position** (of the valve: service, fill, brine, backwash, fast rinse or moving) See "Manual Advance Recharge Check" on next page for position verification.
 - **Requested position** (of the valve)
 - **Motor state** (on or off)
 - **Valve position switch** (open or closed)
 - **Turbine count** (indicates water flow) See following section for turbine diagnostics.
 - **Salt level sensor** (distance reading of sensor)
 - **Drain TDS** (total dissolved solids in ppm)
 - **Drain temperature** (°C)
 - **Tank light switch** (open or closed)
 - **RF module** (detected or not)
 - **Error code**

CHECKING THE TURBINE

1. Display the **Diagnostics** screen, following the procedure on Page 30.
2. Press the DOWN (▼) button to scroll through the list until **Turbine Count** is displayed (See Figure 103).

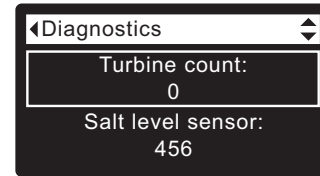

FIG. 103

3. A steady display of "0" (zero) indicates no water flow through the meter (i.e. no conditioned water being used).
4. Open a nearby conditioned water faucet.
5. The number in the display should count upward from 0 and reset at 151 for each gallon of flow.
6. If the display reading does not change with the faucet open, pull the wire harness from the valve outlet port (See Figure 104).

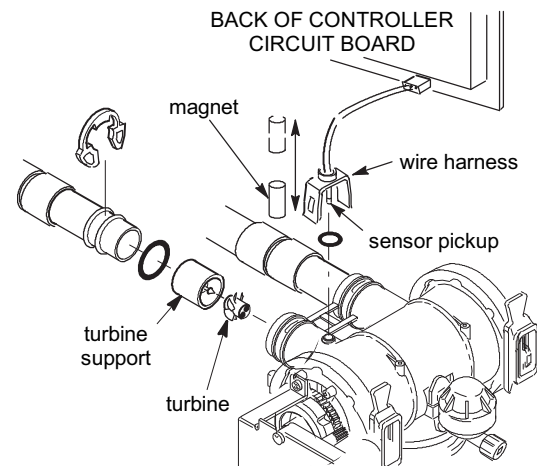

FIG. 104

7. Pass a small magnet back and forth in front of the sensor.
- 8a. If the displayed **Turbine Count** does count upward with each pass of the magnet, disconnect the outlet plumbing and check the turbine for binding.
- 8b. If the displayed **Turbine Count** does not count upward with each pass of the magnet, the sensor is probably faulty.

TROUBLESHOOTING - MANUAL ADVANCE RECHARGE CHECK

This check verifies proper operation of the position switch, gear motor, brine tank fill, brine draw, recharge flow rates, and other controller functions. Always make the Initial Checks (See Page 34) and the Manual Diagnostics (See Page 35) first.

1. Display the **Diagnostics** screen, following the procedure on Page 30.
2. Press the DOWN (▼) button to scroll through the list until **Valve position switch** is displayed (See Figure 105).

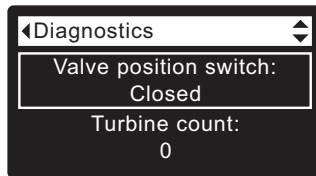

FIG. 105

3. Verify that when the switch plunger is down (into one of the detents on the valve motor cam), this screen reads **Open**. When the valve cam is rotating (for example, after Step 7, below), the switch plunger will be up and this screen should read **Closed**.
4. Press the UP (▲) button to scroll through the list until **Current position** is displayed (See Figure 106).

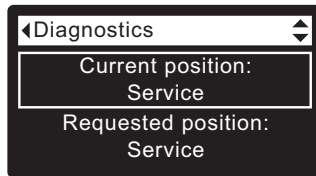

FIG. 106

5. Verify that the valve position indicator on the motor cam agrees with the position displayed on the screen
6. Remove the brinewell cover.
7. With the Diagnostics screen displayed, press the RIGHT (▶) button once to advance the valve from **Service** to **Fill**.
8. Shine a flashlight into the brinewell and observe fill water entering the tank.
9. If water does not enter the tank, look for an obstructed nozzle / venturi, fill flow plug or brine tube (See Figure 98 on Page 32).
10. After verifying fill, press the RIGHT (▶) button once to move the valve into **Brine***. A slow flow of water to the drain will begin. Verify brine draw from the brine tank by shining the flashlight into the brinewell to observe a noticeable drop in the liquid level.

* If the 2nd Backwash option is set "On" (See Page 26), the valve will enter backwash and fast rinse before brine.

11. If the unit does not draw brine, check for:
 - Dirty or defective nozzle / venturi (See Page 32)
 - Nozzle / venturi not seated on the gasket or gasket not sealing properly
 - Restriction in valve drain, causing back pressure (bends, kinks, elevated too high, etc.)
 - Obstruction in valve or brine tubing
 - Internal valve fault (obstructed outlet disc, wave washer faulty etc.)
12. With the Diagnostics screen displayed, once again press the RIGHT (▶) button to advance the valve to **Backwash**.
13. Look for a fast flow of water from the drain hose. If flow is slow, check for a plugged top distributor, backwash flow plug or drain hose
14. With the Diagnostics screen displayed, once again press the RIGHT (▶) button to advance the valve to **Fast rinse**.
15. Again, look for a fast flow of water from the drain hose. Allow the unit to rinse for several minutes to flush out any brine that may remain from the brine cycle test.
16. With the Diagnostics screen displayed, once again press the RIGHT (▶) button to return the valve to the **Service** position.

IMPORTANT: Always return the valve to the **Service** position before exiting this procedure.

OTHER SERVICE

Hard Water Bypass (Hard water "bleeds" into conditioned water supply):

1. Faulty inlet disc, seal or wave washer (See Pages 42 and 43).
2. Missing or faulty o-ring(s) at valve connection to riser pipe.

Water Leaks from Drain Hose during service:

1. Faulty inlet disc, seal or wave washer.
2. Faulty o-ring on inlet disc shaft.
3. Faulty outlet disc, seal or wave washer.

Flooded Salt Tank:

1. Nozzle / venturi plugged.
2. Faulty valve seals.
3. Restricted or plugged backwash / fast rinse controls.
4. Restricted or plugged drain line.

Water Has Salty Taste:

1. House water pressure low. Adjust well pump.
2. Partially restricted valve drain hose, top distributor, backwash flow plug, resin tank internal riser pipe, or bottom distributor.
3. Backwash and fast rinse times have been reduced from default settings.
4. Wrong model code.

WIRING SCHEMATIC

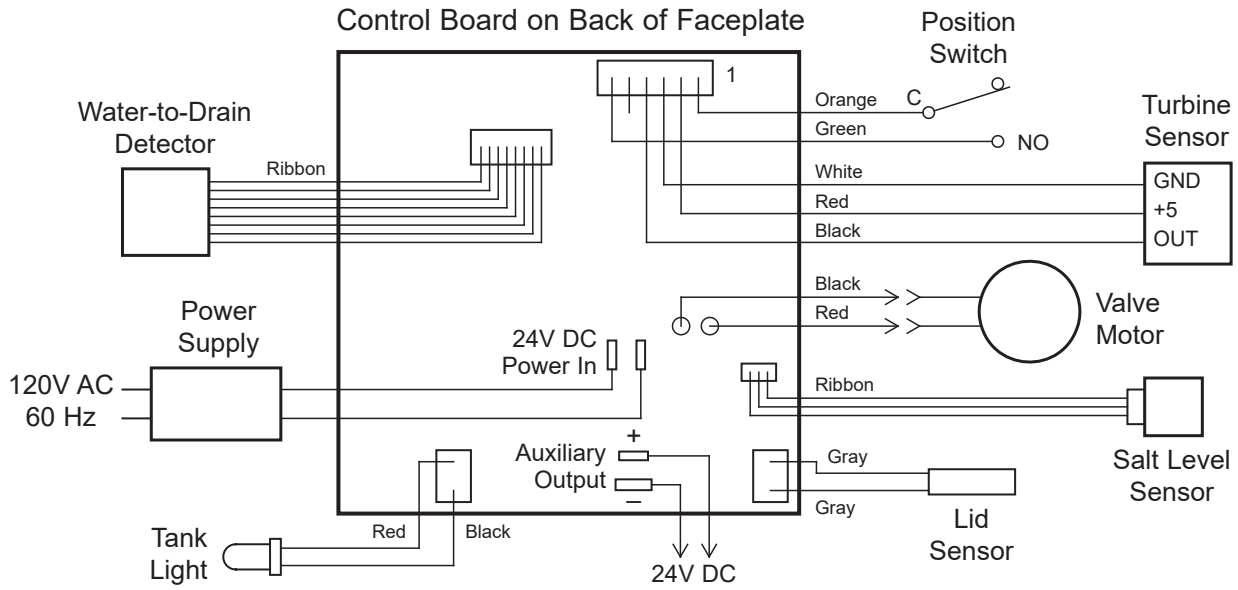

FIG. 107

BRINE TANK & RIM IDENTIFICATION

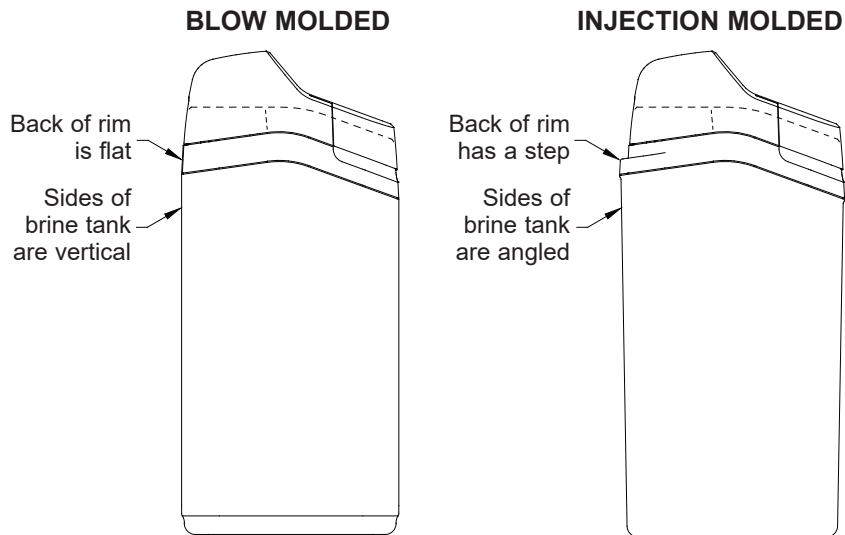
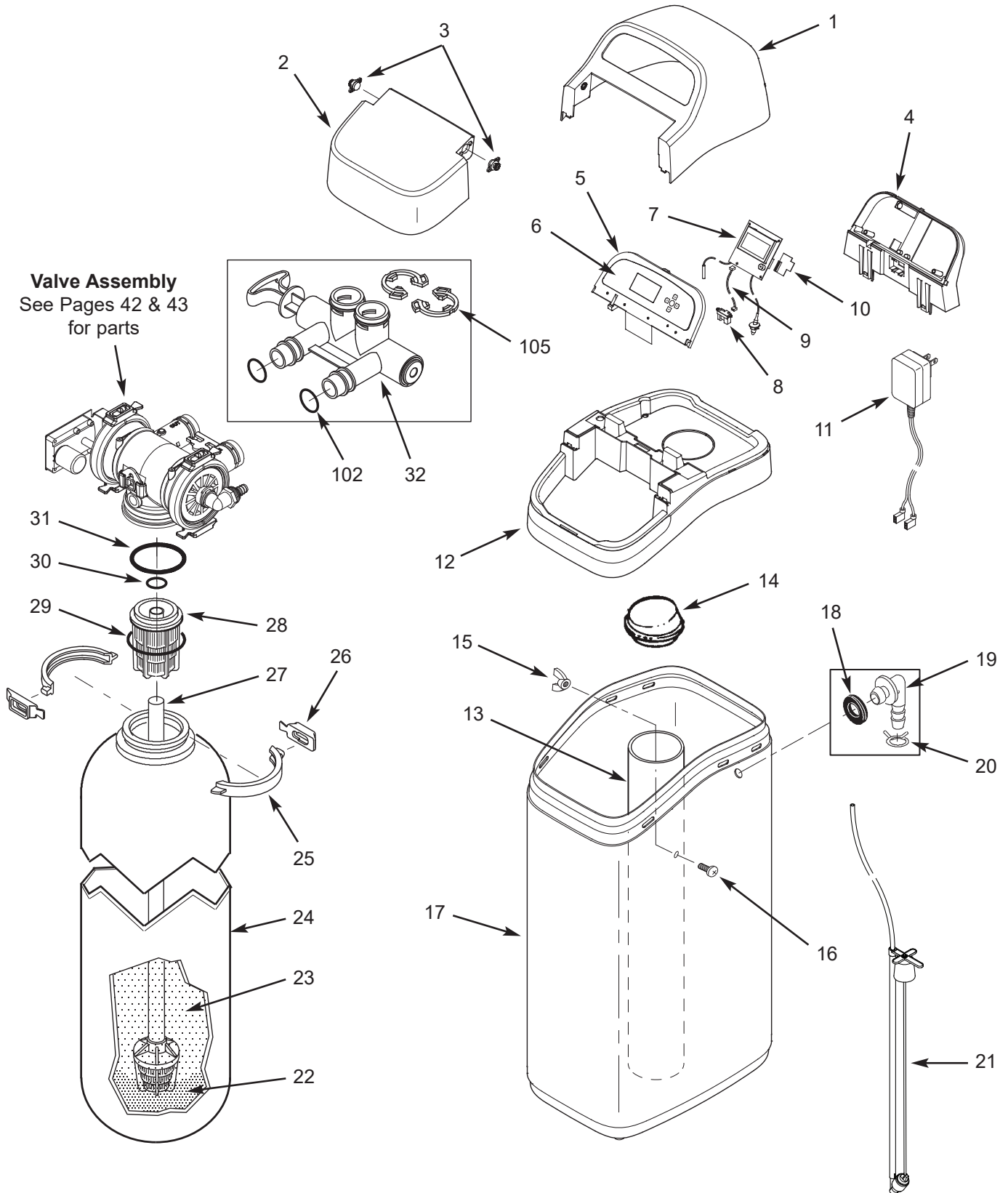

FIG. 108

ECOWATER SYSTEMS CONDITIONER/REFINER ASSEMBLY
(Cabinet Models)



ECOWATER SYSTEMS CONDITIONER/REFINER ASSEMBLY (Cabinet Models)

Key No.	Part No.	Description
–	7354808	Cover Assembly (includes Key Nos. 1-3)
1	↑	Cover, Top
2	↑	Salt Lid, with magnet
3	↑	Damper/Hinge (2 req.)
4	7367851	Support, Faceplate
–	7357856	Repl. Faceplate Assembly (includes Key Nos. 5-9)
5	↑	Faceplate
6	↑	Keypad/Decal
7	↑	Electronic Controller (PWA), with Tank Light Assembly & Lid Sensor
–	7357880	Repl. Salt Level Sensor Assembly (includes Key Nos. 8 & 9)
8	↑	Salt Level Sensor, Long Range (also incl. in Repl. Faceplate Asm.)
9	↑	Cable, Salt Level Sensor (also incl. in Repl. Faceplate Asm.)
10	7341520	Repl. Wi-Fi Board
11	7351054	Power Supply, 24V DC
12	7353307	Rim, ECR3700R20 & ECR3700R30 with Blow Molded Brine Tank ♦
	7357521	Rim, ERR3700R20 with Blow Molded Brine Tank ♦
	7384895	Rim, ECR3700R20 & ECR3700R30 with Injection Molded Brine Tank
	7387097	Rim, ERR3700R20 with Injection Molded Brine Tank
13	7214375	Brinewell
14	7155115	Cover, Brinewell
–	7357822	Brinewell Mounting Hardware Kit, (includes Key Nos. 15 & 16)
15	↑	Nut
16	↑	Screw

Key No.	Part No.	Description
17	7353187	Brine Tank, Blow Molded ♦
	7384887	Brine Tank, Injection Molded
–	7331258	Overflow Hose Adaptor Kit (includes Key Nos. 18-20)
18	↑	Grommet
19	↑	Adaptor Elbow
20	↑	Hose Clamp *
21	7380956	Brine Valve Assembly
22	7124415	Gravel, 17 lbs.
23	0502272	Resin, 1 cu. ft. (standard mesh)
	7052202	Resin, 1 cu. ft. (fine mesh)
	7175149	Activated Carbon (ERR3700R20)
24	7304235	Resin Tank, 8" dia. x 35," ECR3700R20
	7113066	Resin Tank, 10" dia. x 35" L, ECR3700R30 & ERR3700R20 with Blow Molded Brine Tank ♦
	7334696	Resin Tank, 10" dia. x 35" S, ECR3700R30 & ERR3700R20 with Injection Molded Brine Tank
–	7331177	Tank Neck Clamp Kit (includes 2 ea. of Key Nos. 25 & 26)
25	↑	Clamp Section (2 req.)
26	↑	Retainer Clip (2 req.)
27	7105047	Repl. Bottom Distributor
28	7077870	Top Distributor
–	7112963	Distributor O-Ring Kit (includes Key Nos. 29-31)
29	↑	O-Ring, 2-3/4" x 3"
30	↑	O-Ring, 13/16" x 1-1/16"
31	↑	O-Ring, 2-7/8" x 3-1/4"
32	7214383	Bypass Valve, 1" * (includes 2 ea. of Key Nos. 102 & 105)

♦ Blow molded brine tanks were used exclusively prior to 2022, and on some units manufactured later. Rims for blow molded brine tanks will only fit that type, and rims for injection molded brine tanks will only fit that type. See Figure 108 on Page 37.

* Not included with the conditioner/refiner.

To order parts, call your local EcoWater dealer or go to www.ecowater.com to locate a dealer in your area.

ECOWATER SYSTEMS CONDITIONER/REFINER ASSEMBLY
(Two-Tank Models)

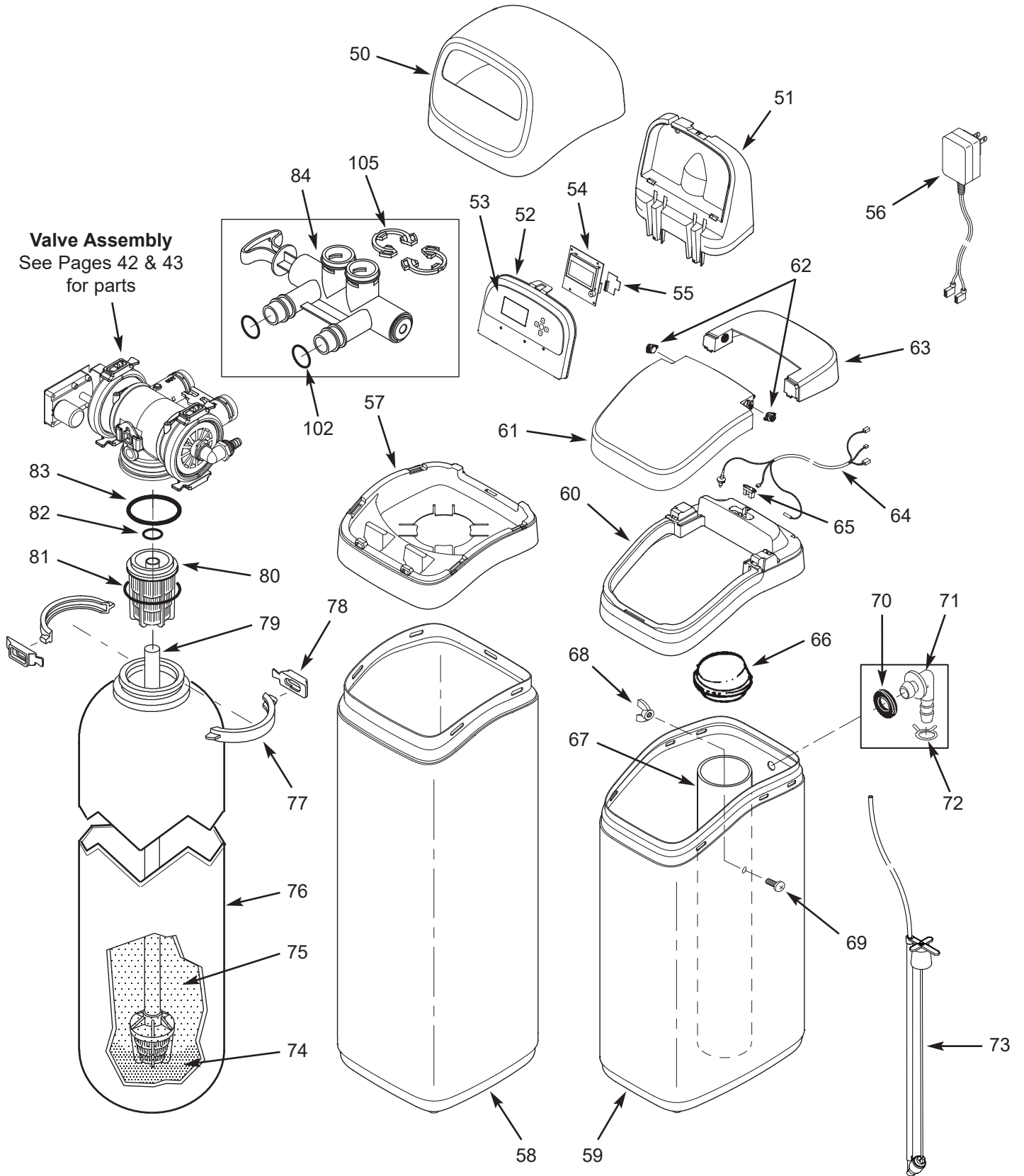

ECOWATER SYSTEMS CONDITIONER/REFINER ASSEMBLY (Two-Tank Models)

Key No.	Part No.	Description
50	7353365	Cover, Top
51	7353381	Support, Faceplate
–	7365647	Repl. Faceplate Assembly (includes Key Nos. 52-54 & 65)
52	↑	Faceplate
53	↑	Keypad/Decal
54	↑	Electronic Controller (PWA)
55	7341520	Repl. Wi-Fi Board
56	7351054	Power Supply, 24V DC
57	7353357	Rim, ECR3702R30, ECR3702R40, ECR3702R50S & ECR3702R70
	7357539	Rim, ERR3702R30, ERR3702R50 & ERRC3702R50
58	7353226	Shroud, 35" (ECR3702R30)
	7353234	Shroud, 47" (ERR3702R30 & ECR3702R40)
	7353242	Shroud, 54" (R50 & R70 models)
59	7353187	Brine Tank, Blow Molded ♦
	7384887	Brine Tank, Injection Molded
60	7362403	Rim, ECR3702R30, ECR3702R40, ECR3702R50S & ECR3702R70 with Blow Molded Brine Tank ♦
	7365388	Rim, ERR3702R30, ERR3702R50 & ERRC3702R50 with Blow Molded Brine Tank ♦
	7384900	Rim, ECR3702R30, ECR3702R40, ECR3702R50S & ECR3702R70 with Injection Molded Brine Tank
	7387110	Rim, ERR3702R30, ERR3702R50 & ERRC3702R50 with Injection Molded Brine Tank
–	7364162	Cover Assembly, Brine Tank (includes Key Nos. 61-63)
61	↑	Salt Lid, with magnet
62	↑	Damper/Hinge (2 req.)
63	↑	Cover, Brine Tank
64	7363514	Cable, Brine Tank
65	7365736	Salt Level Sensor, Long Range
66	7155115	Cover, Brinewell
67	7109871	Brinewell

Key No.	Part No.	Description
–	7357822	Brinewell Mounting Hardware Kit, (includes Key Nos. 68 & 69)
68	↑	Nut
69	↑	Screw
–	7331258	Overflow Hose Adaptor Kit (includes Key Nos. 70-72)
70	↑	Grommet
71	↑	Adaptor Elbow
72	↑	Hose Clamp *
73	7380956	Brine Valve Assembly
74	7124415	Gravel, 17 lbs.
75	0502272	Resin, 1 cu. ft. (standard mesh)
	7052202	Resin, 1 cu. ft. (fine mesh)
	7175149	Activated Carbon (ERR3702R30 & ERR3702R50)
	7339141	Catalytic Carbon, 1 cu. ft. (ERRC3702R50)
76	7113066	Resin Tank, 10" dia. x 35" (ECR3702R30)
	7092202	Resin Tank, 10" dia. x 47" (ERR3702R30 & ECR3702R40)
	7113074	Resin Tank, 12" dia. x 54" (R50 & R70 models)
–	7331177	Tank Neck Clamp Kit (includes 2 ea. of Key Nos. 77 & 78)
77	↑	Clamp Section (2 req.)
78	↑	Retainer Clip (2 req.)
79	7105047	Repl. Bottom Distributor
80	7077870	Top Distributor
–	7112963	Distributor O-Ring Kit (includes Key Nos. 81-83)
81	↑	O-Ring, 2-3/4" x 3"
82	↑	O-Ring, 13/16" x 1-1/16"
83	↑	O-Ring, 2-7/8" x 3-1/4"
84	7214383	Bypass Valve, 1" * (includes 2 ea. of Key Nos. 102 & 105)

♦ Blow molded brine tanks were used exclusively prior to 2022, and on some units manufactured later. Rims for blow molded brine tanks will only fit that type, and rims for injection molded brine tanks will only fit that type. See Figure 108 on Page 37.

* Not included with the conditioner/refiner.

VALVE ASSEMBLY (All Models)

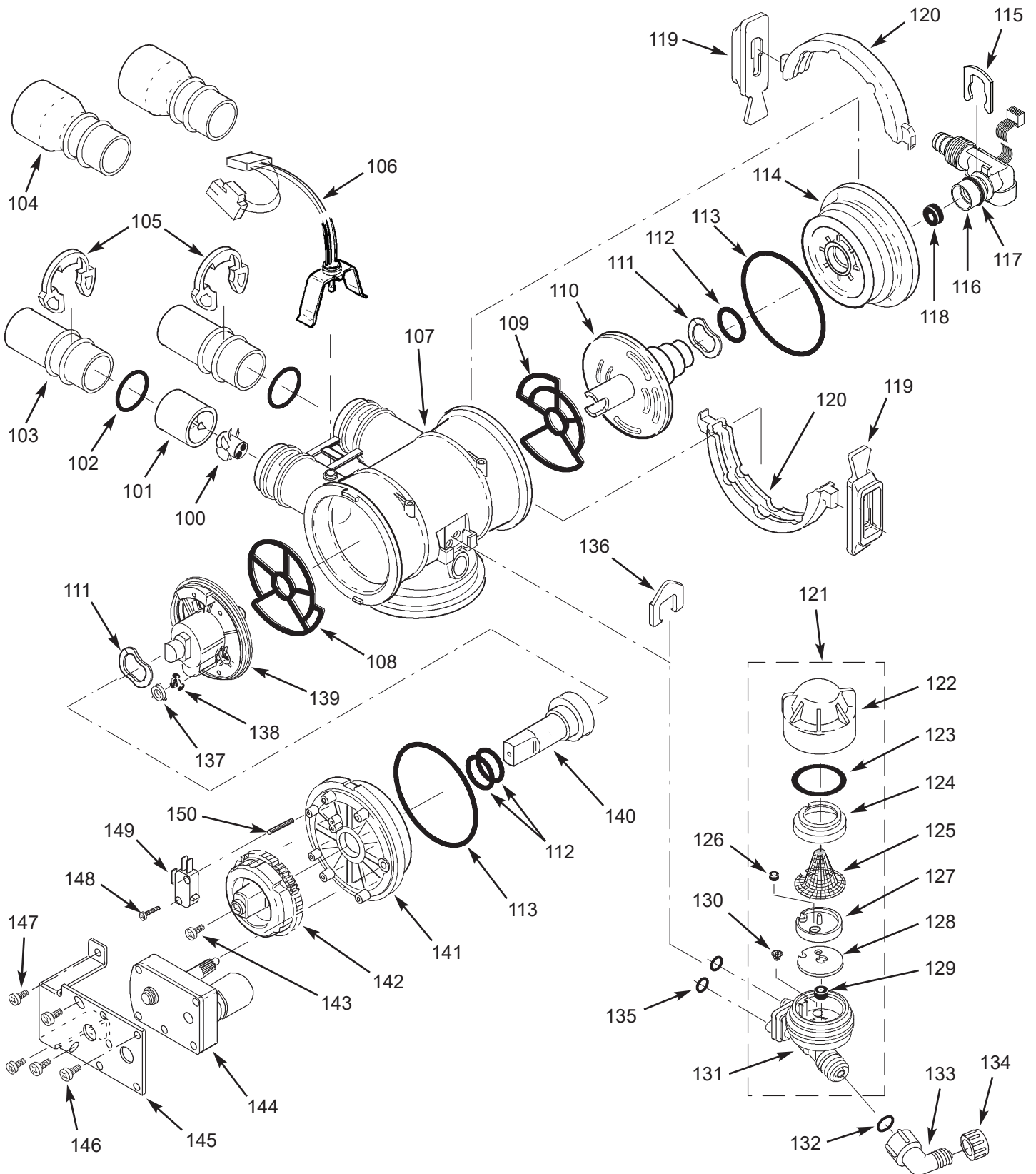

VALVE ASSEMBLY (All Models)

Key No.	Part No.	Description
-	7290931	Turbine & Support Assembly, including 2 O-Rings (See Key No. 102) & 1 ea. of Key Nos. 100 & 101, ECR3700R20, ERR3700R20, ECR3700R30 & ECR3702R30
	7331703	Turbine & Support Assembly (includes 1 ea. of Key Nos. 100, 101 & 2 ea. of Key No. 102), ERR-3702R30, R40, R50 & R70 models
100	↑	Turbine
101	↑	Turbine Support & Shaft
102	7311127	O-Ring, 1-1/16" x 1-5/16", single (2 req.)
	7336410	O-Ring, 1-1/16" x 1-5/16", pack of 20
103	7077642	Copper Tube, 1", single (2 req.)
	7344138	Copper Tube, 1", pack of 10 (includes 10 ea. of Key No. 52)
104	7234553	Copper Tube, 1-1/4" pipe (2 req.)
105	7089306	Clip, 1", single (2 req.)
	7336428	Clip, 1", pack of 20
106	7309811	Wire Harness w/pos. switch conn.
107	7159949	Disc Valve Housing
108	7334133	Outlet End Seal, single ❶
	7353404	Outlet End Seal, pack of 20
109	7334125	Inlet End Seal, single ❶
	7353399	Inlet End Seal, pack of 20
-	7135270	Inlet & Outlet End Seal Kit (includes 1 ea. of Key Nos. 108 & 109)
110	7390236	Inlet Disc, single ❶
	7368475	Inlet Disc, pack of 10
111	7058216	Wave Washer (2 req.)
112	7170220	O-Ring, 3/4" x 15/16", single (3 req.) ❶
	7336444	O-Ring, 3/4" x 15/16", pack of 30
113	7170296	O-Ring, 2-7/8" x 3-1/4", single (2 req.)
	7336452	O-Ring, 2-7/8" x 3-1/4", pack of 20
114	7077498	Inlet End Cap
115	7142942	Clip, Drain
116	7357830	Drain Elbow Assembly w/Water-to-Drain Sensor (includes Key No. 117)
117	7170327	O-Ring, 5/8" x 13/16"
118	1110600	Flow Plug, Fast Rinse, 2.4 gpm, ECR3700R20
	7097969	Flow Plug, Fast Rinse, 3.0 gpm, ERR3700R20, R30 & R40 models
	7097977	Flow Plug, Fast Rinse, 4.0 gpm, R50 & R70 models
-	7331177	Tank Neck Clamp Kit (includes 2 ea. of Key Nos. 119 & 120)
119	↑	Retainer Clip (4 req.) ❷
120	↑	Clamp Section (4 req.) ❷

- ❶ Included in Disc Kit, #7218688
- ❷ Not all parts are shown
- ❸ Use red nozzle along with Key No. 126 on water pressures of 50 psi or less

Key No.	Part No.	Description
121	7137507	Nozzle & Venturi Assembly (includes Key Nos. 122-131), ECR3700R20 ❸
	7091866	Nozzle & Venturi Assembly (includes Key Nos. 122-131), ERR3700R20, R30 & R40 models
	7085247	Nozzle & Venturi Assembly (includes Key Nos. 122-131), R50 & R70 models
122	↑	Cap
123	↑	O-Ring, 1-1/8" x 1-3/8"
124	↑	Screen Support
125	↑	Screen
126	↑	Flow Plug, 0.15 gpm, ECR3700R20 ❸
127	↑	Nozzle & Venturi Disc, Red, R20 ❸, R30 & R40 models
		Nozzle Venturi Disc, Blue, R50 & R70 models
128	↑	Gasket
129	↑	Flow Plug, Fill, 0.3 gpm
130	↑	Cone Screen
131	↑	Housing, Nozzle & Venturi
■	7290957	Repl. Nozzle, Venturi & Gasket Kit, (includes Key Nos. 123, 127, 128, 130 & 135), R20 ❸, R30 & R40 models
	7298913	Repl. Nozzle, Venturi & Gasket Kit, (includes Key Nos. 123, 127, 128, 130 & 135), R50 & R70 models
132	7292323	O-Ring, 3/16" x 7/16"
133	7120526	Elbow, 90°
134	1202600	Nut - Ferrule
135	7170319	O-Ring, 1/4" x 3/8" (2 req.)
136	7081201	Clip, Nozzle & Venturi
137	7078313	Retainer ❶
138	7104774	Flow Washer, Backwash, 1.0 gpm, ECR3700R20
	7104570	Flow Washer, Backwash, 1.7 gpm, ERR3700R20, R30 & R40 models - not used on R50 & R70 models
139	7390244	Outlet Disc, single ❶
	7368483	Outlet Disc, pack of 10
140	7091329	Driver, Outlet Disc
141	7159965	Outlet End Cap
142	7283497	Cam & Gear
143	7203104	Washerhead Screw, #8-18 x 1/2"
144	7281275	Motor, incl. Key No.143
145	7289702	Bracket, Motor
146	7168524	Screw, #10-32 x 5/16" (3 req.)
147	7103972	Screw, #8-18 x 7/16" (2 req.)
148	7140738	Screw, #4-24 x 3/4"
149	7145186	Switch
150	7140746	Expansion Pin

■ Not illustrated.

LIMITED WARRANTY

**EcoWater Systems LLC Advantage Warranty
Series 3700 & 3702 Water Conditioning System**

Congratulations! You have just purchased the highest quality water conditioning product on the market.

To whom is this warranty extended?

EcoWater Systems LLC warrants its products to the original purchaser, when the product is purchased from an authorized dealer, and guarantees that the products will be free from defects in materials and workmanship from the date that the product is delivered.

How does my warranty work?

If, during the respective warranty period, a part proves, after inspection by EcoWater, to be defective, EcoWater will, at its sole option repair or replace that part at no charge, other than normal shipping, installation or service charges.

What is covered by the warranty?

EcoWater Systems LLC guarantees that,

for the LIFETIME of the original purchaser, when the product is purchased from an authorized dealer, the SALT TANK and the RESIN/MINERAL TANK will not rust, corrode, leak, burst, or in any other manner fail to perform in accordance with their written specifications, and that,

for a period of TEN (10) YEARS from the date the product is delivered, the VALVE BODY will be free of defects in materials and workmanship and will perform in accordance with their written specifications, and that,

for a period of SEVEN (7) YEARS from the date the product is delivered, the ELECTRONIC FACEPLATE will be free of defects in materials and workmanship and will perform in accordance with its written specifications, and that,

for a period of FIVE (5) YEARS from the date the product is delivered, ALL OTHER PARTS will be free of defects in materials and workmanship and will perform in accordance with their written specifications.

Only on models designated as ERR on the rating decal, is the MEDIA BED guaranteed, for the LIFETIME of the original purchaser, when the product is purchased from an authorized dealer, to be free of defects in materials and workmanship and to reduce chlorine taste and odor from a municipal water supply in accordance with its written specifications.

Only on models designated as ERRC on the rating decal, is the MEDIA BED guaranteed, for a period of TEN (10) YEARS from the date the product is delivered, to reduce chloramines and chlorine taste and odor from a municipal water supply in accordance with its written specifications.

How do I obtain warranty service?

Should you need service, your local, independent EcoWater Dealer is only a phone call away.

PHONE: _____

To obtain warranty service, notice must be given, within thirty (30) days of the discovery of the defect, to your local EcoWater Systems dealer.

If I need a part replaced after the factory warranty expires, is the replacement part warranted?

Yes, EcoWater Systems LLC warrants FACTORY REPAIRS as well as all REPLACEMENT PARTS for a period of 90 DAYS. This warranty does not include normal shipping, installation or service charges.

Are any additional warranties available?

We are pleased to say, YES! EcoWater Systems LLC sells an EXTENDED, PARTS ONLY WARRANTY for the ELECTRONICS portion of your product. This warranty is called the "Perfect 10" and extends the warranty on the electronic FACEPLATE, WIRING HARNESS, DRIVE MOTOR, POWER SUPPLY, POWER CORD, SENSOR HOUSING, and MICRO SWITCHES to a total of TEN (10) YEARS from the date the product is delivered. Your local dealer will provide details regarding this warranty or will refer you to the factory for additional information. In addition, the 3700 & 3702 SERIES product carries the CREST OF EXCELLENCE GUARANTEE that, should you experience a repetitive problem that remains uncorrected, EcoWater will, during the FIRST YEAR from the date the product is delivered, replace the product with the exact or comparable product. This guarantee may be subject to normal shipping and installation or service charges.

General Provisions

The above warranties are effective provided the water conditioning system is operated at water pressures not exceeding 125 psi (8.8 kg/cm²), and at water temperatures not exceeding 120°F (49°C) [and on a municipal chlorinated water supply - models designated as ERR on the rating decal]; provided further that the water conditioning system is not subject to abuse, misuse, alteration, neglect, freezing, accident or negligence; and provided further that the water conditioning system is not damaged as the result of any force of nature such as, but not limited to, flood, hurricane, tornado or earthquake.

The limited warranty does not cover damage due to: (a) transportation, (b) storage, (c) improper use, (d) failure to follow the product instructions or to perform any preventive maintenance, (e) modifications, (f) unauthorized repair, (g) normal wear and tear, or (h) external causes such as accidents, abuse, or other actions or events beyond Warrantor's reasonable control. Use of aftermarket, used, or non-manufacturer provided parts will void all warranties. Warranty does not cover failures due to improper product installation. Warrantor is excused if failure to perform its warranty obligations is the result of strikes, government regulation, materials shortages, or other circumstances beyond its control.

THERE ARE NO WARRANTIES ON THE WATER CONDITIONING SYSTEM BEYOND THOSE SPECIFICALLY DESCRIBED ABOVE. ALL IMPLIED WARRANTIES, INCLUDING ANY IMPLIED WARRANTY OF MERCHANTABILITY OR OF FITNESS FOR A PARTICULAR PURPOSE, ARE DISCLAIMED TO THE EXTENT THEY MIGHT EXTEND BEYOND THE ABOVE PERIODS. THE SOLE OBLIGATION OF WARRANTOR UNDER THESE WARRANTIES IS TO REPLACE OR REPAIR THE COMPONENT OR PART WHICH PROVES TO BE DEFECTIVE WITHIN THE SPECIFIED TIME PERIOD, AND WARRANTOR IS NOT LIABLE FOR CONSEQUENTIAL OR INCIDENTAL DAMAGES. NO DEALER, AGENT, REPRESENTATIVE, OR OTHER PERSON IS AUTHORIZED TO EXTEND OR EXPAND THE WARRANTIES EXPRESSLY DESCRIBED ABOVE.

Some states do not allow the exclusion or limitation of incidental or consequential damages, so the above limitation or exclusion may not apply to you. This warranty gives you specific legal rights, and you may have other rights which vary from state to state. This warranty applies to consumer-owned installations only.